

---

# User's and Service Guide

Publication number D3000-97000  
March 2005

© Copyright Agilent Technologies 2005  
All Rights Reserved

---

## 3000 Series Oscilloscopes

---

## In This Book

This book gives you the information you need to begin using the 3000 Series Oscilloscopes. It contains the following chapters:

**Getting Started** Chapter 1 contains inspection, power requirements, probe compensation instructions, cleaning instructions, and setup information.

**Using the Oscilloscope** Chapter 2 gives information on how to use the front panel and the graphical user interface, and tells you how to perform various operations with the oscilloscope.

**Specifications and Characteristics** Chapter 3 gives specification and characteristics of the oscilloscope.

**Service** Chapter 4 gives service and performance testing information for the oscilloscope.

---

# Contents

## 1 Getting Started

- Inspecting the Package Contents 1-2
- Performing a Functional Check 1-5
- Compensating Probes 1-7
- Front Panel and User Interface Descriptions 1-9
- Automatically Displaying a Waveform 1-12
- Cleaning the Oscilloscope 1-13

## 2 Using the Oscilloscope

### Vertical Controls 2-3

- Vertical System Setup 2-4
- Channel Coupling Control 2-6
- Bandwidth Limit Control 2-9
- Probe Attenuation Control 2-11
- Invert Control 2-12
- Digital Filter Controls 2-14
- Math Functions Control 2-15
- Reference Control 2-19
- Removing Waveforms from the Display 2-21

### Horizontal Controls 2-22

- Horizontal System Setup 2-23
- Horizontal Knobs 2-24
- Horizontal Menu 2-25
- Roll Mode 2-29

### Trigger Controls 2-30

- Trigger System Setup 2-31
- Trigger Modes 2-33

### Waveform Controls 2-37

- Stop Acquisition 2-38
- Equivalent Time Sampling 2-38
- Average Acquisition 2-38
- Peak Detect 2-40
- Sequence Capability 2-41

### Display Controls 2-43

### Save and Recall Controls 2-45

## Contents

- Waveforms 2-46
- Setups 2-46
- Default Setup 2-46
- Load 2-46
- Save 2-46

### Utility Controls 2-47

- Mask Test 2-49
- I/O Setup Menu 2-51
- System Info 2-52
- Self-Calibration 2-53
- Self-Test 2-54

### Automatic Measurement Controls 2-55

- Voltage Measurements 2-56
- Time Measurements 2-57
- Automatic Measurement Procedure 2-58
- Measurement Concepts 2-59

### Cursor Measurement Controls 2-63

- Manual 2-64
- Track 2-66
- Auto Measure 2-67

### Autoscale and Run/Stop Controls 2-68

- Autoscale Button 2-69
- Run/Stop Button 2-71

## 3 Specifications and Characteristics

- Specifications 3-2
- Characteristics 3-3

## 4 Service



Returning the oscilloscope to Agilent Technologies for service 4-2

### Testing Performance 4-3

- Before Performing Performance Verification Testing 4-5
- DC Gain Accuracy Test 4-7
- Analog Bandwidth - Maximum Frequency Check 4-13
- Performance Test Record 4-21

---

Getting Started

## Inspecting the Package Contents

❑ Inspect the shipping container for damage.

Keep a damaged shipping container or cushioning material until you have inspected the contents of the shipment for completeness and have checked the oscilloscope mechanically and electrically.

❑ Verify that you received the following items in the oscilloscope packaging.

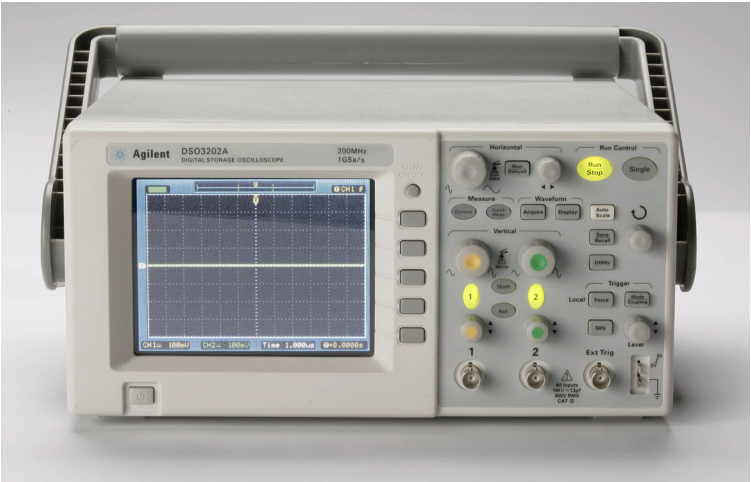
- Oscilloscope
- (2) N2862A 10:1 10 M $\Omega$  passive probes (60 MHz and 100 MHz models)
- (2) N2863A 10:1 10 M $\Omega$  passive probes (150 MHz and 200 MHz models)
- CD-ROM containing user documentation

See Figure 1-1. (See table 1-1 for the power cord.) If anything is missing, contact your nearest Agilent Technologies Sales Office. If the shipment was damaged, contact the carrier, then contact the nearest Agilent Technologies Sales Office.

❑ Inspect the oscilloscope.

- If there is mechanical damage or a defect, or if the oscilloscope does not operate properly or does not pass performance tests, notify your Agilent Technologies Sales Office.
- If the shipping container is damaged, or the cushioning materials show signs of stress, notify the carrier and your Agilent Technologies Sales Office. Keep the shipping materials for the carrier's inspection. The Agilent Technologies Sales Office will arrange for repair or replacement at Agilent's option without waiting for claim settlement.

Figure 1-1





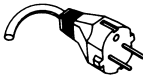
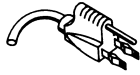




CD-ROM Manuals

Package Contents

Getting Started  
Inspecting the Package Contents

**Table 1-1**

**Power Cords**

	Plug Type	Cable Part No.	Plug Description	Length (in/cm)	Color	Country
250V		8120-1351 8120-1703	Straight *BS1363A 90°	90/228 90/228	Gray Mint Gray	United Kingdom, Cyprus, Nigeria, Zimbabwe, Singapore
250V		8120-1369 8120-0696	Straight *NZSS198/ASC 90°	79/200 87/221	Gray Mint Gray	Australia, New Zealand
250V		8120-1689 8120-1692 8120-2857	Straight *CEE7-Y11 90° Straight (Shielded)	79/200 79/200 79/200	Mint Gray Mint Gray Coco Brown	East and West Europe, Saudi Arabia, So. Africa, India (unpolarized in many nations)
125V		8120-1378 8120-1521 8120-1992	Straight *NEMA5-15P 90° Straight (Medical) UL544	90/228 90/228 96/244	Jade Gray Jade Gray Black	United States, Canada, Mexico, Philippines, Taiwan
250V		8120-2104 8120-2296	Straight *SEV1011 1959-24507	79/200 79/200	Mint Gray Mint Gray	Switzerland
220V		8120-2956 8120-2957	Straight *DHCK107 90°	79/200 79/200	Mint Gray Mint Gray	Denmark
250V		8120-4211 8120-4600	Straight SABS164 90°	79/200 79/200	Jade Gray	Republic of South Africa India
100V		8120-4753 8120-4754	Straight MIT1 90°	90/230 90/230	Dark Gray	Japan

\* Part number shown for plug is the industry identifier for the plug only. Number shown for cable is the Agilent part number for the complete cable including the plug.

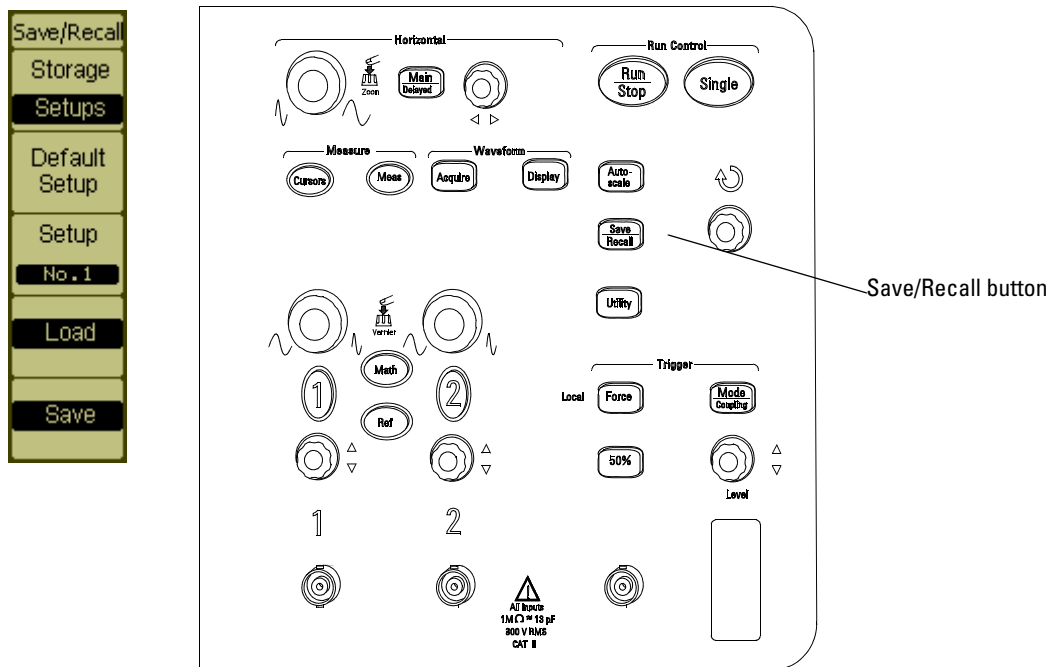


## Performing a Functional Check

Perform this quick functional check to verify that your oscilloscope is operating correctly. See Figure 1-2.

- 1 Turn on the oscilloscope. Use only power cords designed for your oscilloscope. Use a power source that delivers 100 to 240 VAC, 47 Hz to 440 Hz. Wait until the display shows that all self-tests passed. Push the **Save/Recall** button, select **Setup** in the top menu box and push the **Default Setup** menu box.

Figure 1-2



Front Panel Controls

### **WARNING**

To avoid electric shock, be sure the oscilloscope is properly grounded.

- 2 Input a waveform to a channel of the oscilloscope.
- 3 Press the **Autoscale** button and observe the signal on the display.

---

**CAUTION**



To avoid damage to the oscilloscope, make sure that the input voltage at the BNC connector does not exceed the maximum voltage (300 Vrms maximum).

---

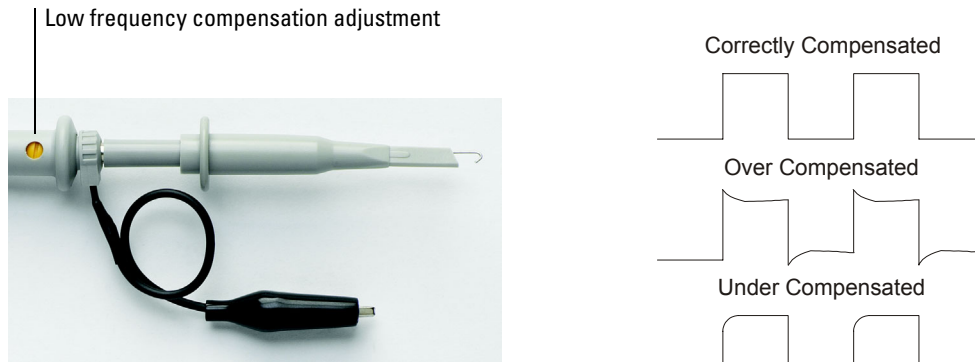
## Compensating Probes

Perform this adjustment to match your probe to the input channel. This should be done whenever you attach a probe for the first time to any input channel.

### Low Frequency Compensation

- 1 Set the Probe menu attenuation to 10X. Press the appropriate channel button on the front panel (**1** or **2**), then select the **Probe** menu item until **10X** appears.
- 2 Attach the probe tip to the probe compensation connector and the ground lead to the probe compensator ground connector. If you use the probe hook-tip, ensure a proper connection by firmly inserting the tip onto the probe.
- 3 Press the **Autoscale** front panel button.

Figure 1-3



### Probe Compensation

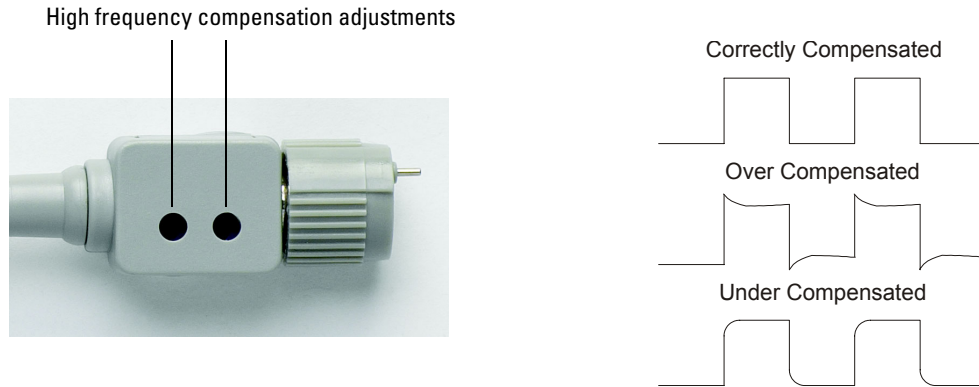
- 4 If the waveform does not appear like the **Correctly Compensated** waveform shown in Figure 1-3, then use a nonmetallic tool to adjust the low frequency compensation adjustment on the probe for the flattest square wave possible.

### High Frequency Compensation

- 1 Using the BNC adapter, connect the probe to a square wave generator.

- 2 Set the square wave generator to a frequency of 1 MHz and an amplitude of 1 Vp-p.
- 3 Press the **Autoscale** front panel button.

Figure 1-4



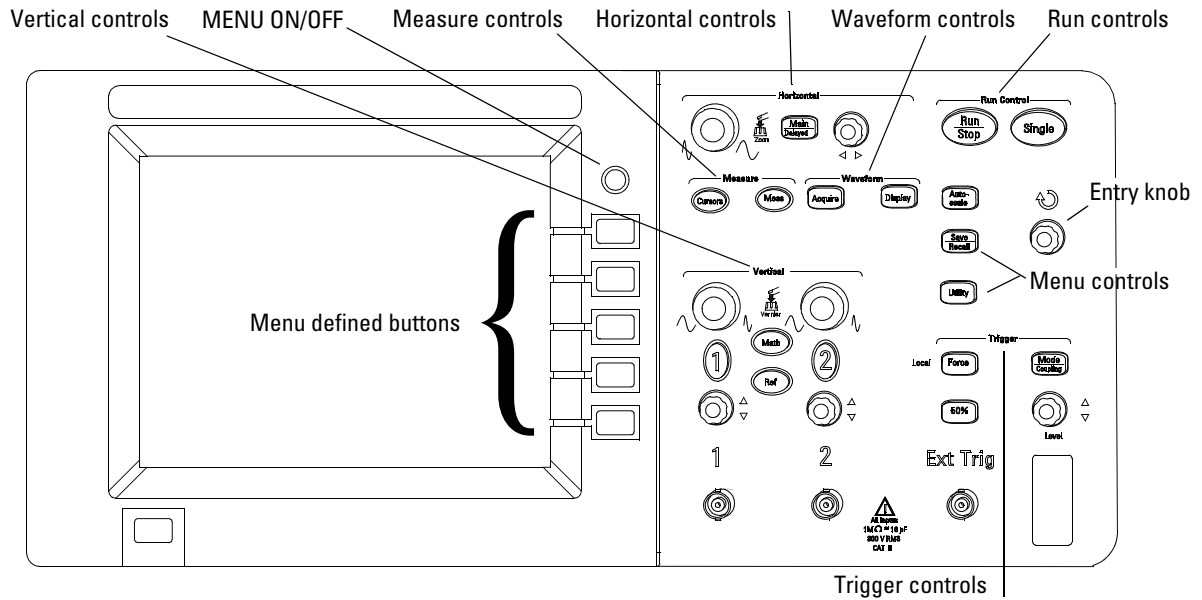
**Probe Compensation**

- 4 If the waveform does not appear like the Correctly Compensated waveform shown in Figure 1-4, then use a nonmetallic tool to adjust the 2 high frequency compensation adjustments on the probe for the flattest square wave possible.

## Front Panel and User Interface Descriptions

One of the first things you will want to do with your new oscilloscope is to become acquainted with its front panel. The front panel has knobs and buttons. The knobs are used most often and are similar to the knobs on other oscilloscopes.

**Figure 1-5**



**Front Panel**

The definitions of the buttons and the knobs are as follows:

Measure controls

**Meas** and **Cursors**

Waveform controls

**Acquire** and **Display**

Menu controls

**Save/Recall** and **Utility**

Vertical controls

Vertical position knobs, vertical scale knobs, **1**, **2**, **Math** and **Ref** menus

Horizontal controls

Position knob, **Main/Delayed**, and scale knob

Trigger controls

Trigger level knob, **50%**, **Mode/Coupling**, and **Force**

Run controls

**Run/Stop**, **Autoscale**, and **Single**

MENU ON/OFF

Displays or hides the current menu

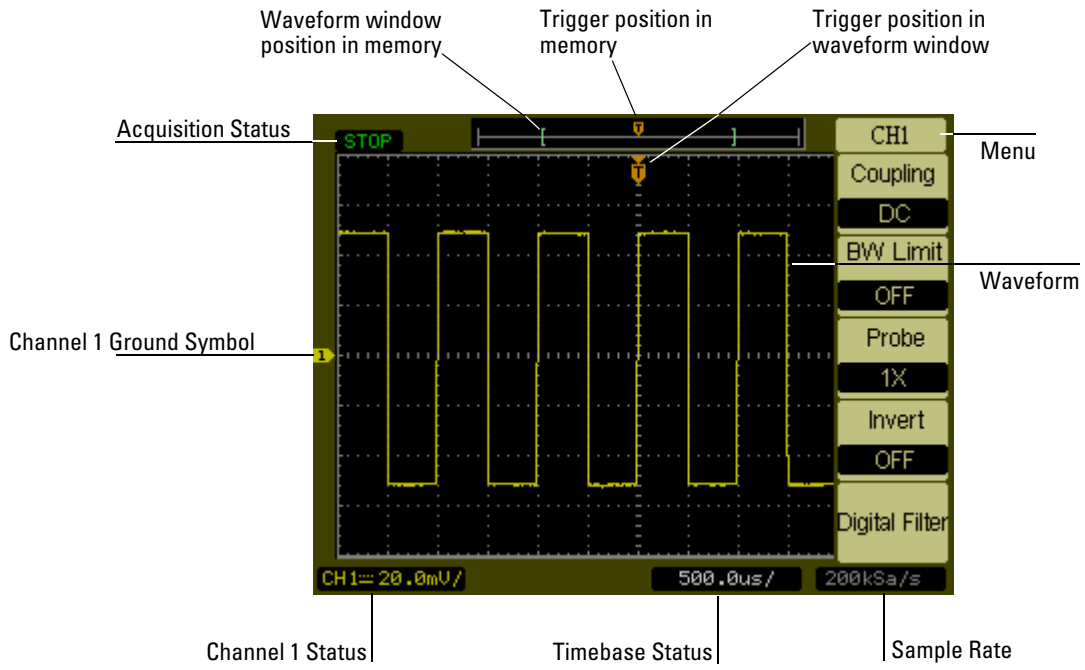
Menu defined buttons

Five gray buttons from top to bottom on the right-hand side of the screen, which select the adjacent menu items in the currently displayed menu. Pressing any of these when no menu is displayed activates the most recently displayed menu.

Entry knob

For the adjustment defined controls

Figure 1-6



User Interface

## Automatically Displaying a Waveform

The oscilloscope has an Autoscale feature that automatically sets up the oscilloscope to best display the input waveform. Using Autoscale requires waveforms with a frequency greater than or equal to 50 Hz and a duty cycle greater than 1%.

When you press the **Autoscale** button, the oscilloscope turns on and scales all channels that have waveforms applied, and selects a time base range based on the trigger source. The trigger source selected is the lowest numbered channel that has a waveform applied. The 3000 Series Oscilloscopes are two channel oscilloscopes with an external trigger input.



---

## Cleaning the Oscilloscope

- Clean the oscilloscope with a soft cloth dampened with a mild soap and water solution.

---

### **CAUTION**

---

Do not use too much liquid in cleaning the oscilloscope. Water can enter the oscilloscope's front panel, damaging sensitive electronic components.



---

## Using the Oscilloscope

---

# Using the Oscilloscope

This chapter describes the oscilloscope's buttons, knobs, and menus. It is recommended that you perform all of the exercises in this chapter to become familiar with the powerful measurement capabilities of the oscilloscope.

---

# Vertical Controls

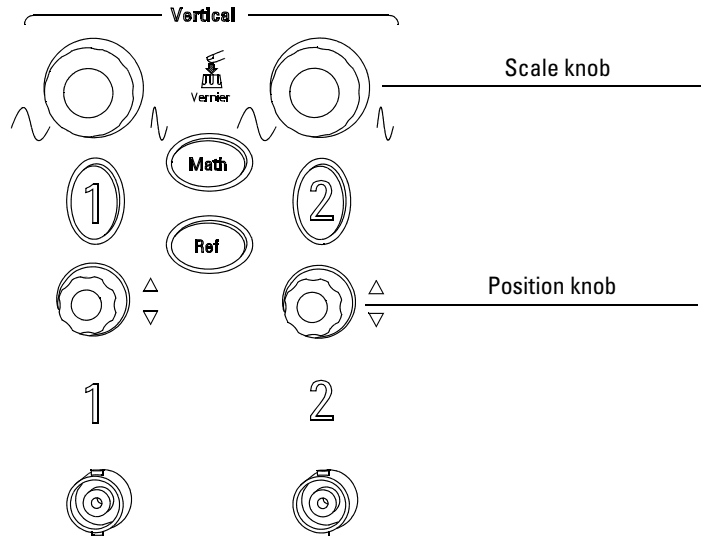
Each channel has a vertical controls menu that appears after pressing either the **1** or the **2** front panel button. This section of the manual describes the vertical channel controls.

---

## Vertical System Setup

Figure 2-1 shows the vertical system controls.

**Figure 2-1**



### Vertical Controls

The following exercise guides you through the vertical buttons, knobs, and status bar.

**1 Center the waveform on the display using the position knob.**

The position knob moves the waveform vertically. Notice that as you turn the position knob, a voltage value is displayed for a short time indicating how far the ground reference is from the center of the screen. Also notice that the ground symbol on the left side of the display moves in conjunction with the position knob.

**Measurement hints**

If the channel is DC coupled, you can quickly measure the DC component of the waveform by simply noting its distance from the ground symbol. If the channel is AC coupled, the DC component of the waveform is blocked, allowing you to use greater sensitivity to display the AC component of the waveform.

- 2** Notice that changing the vertical setup also affects the status bar.  
You can quickly determine the vertical setup from the status bar in the display.
- a** Change the vertical sensitivity with the scale knob and notice that it causes the status bar to change.
  - b** Press the **1** button. The **CH1** menu appears and the channel is turned on.
  - c** Toggle each of the menu buttons and notice which buttons cause the status bar to change.
  - d** Press the **1** button to turn the channel off or on. Press the MENU ON/OFF button to hide the menu without turning the channel off.

Pressing the channel's vertical scale knob toggles its sensitivity between coarse and fine modes. In the coarse mode, the knob changes the **Volts/Div** scale in a 1-2-5 sequence from 2mV/div, 5mV/div, 10mV, ..., to 5 V/div. In the fine mode, the knob changes the **Volts/Div** scale in small steps between the coarse settings. It is helpful when you need to adjust the waveform's vertical size in finer steps.

---

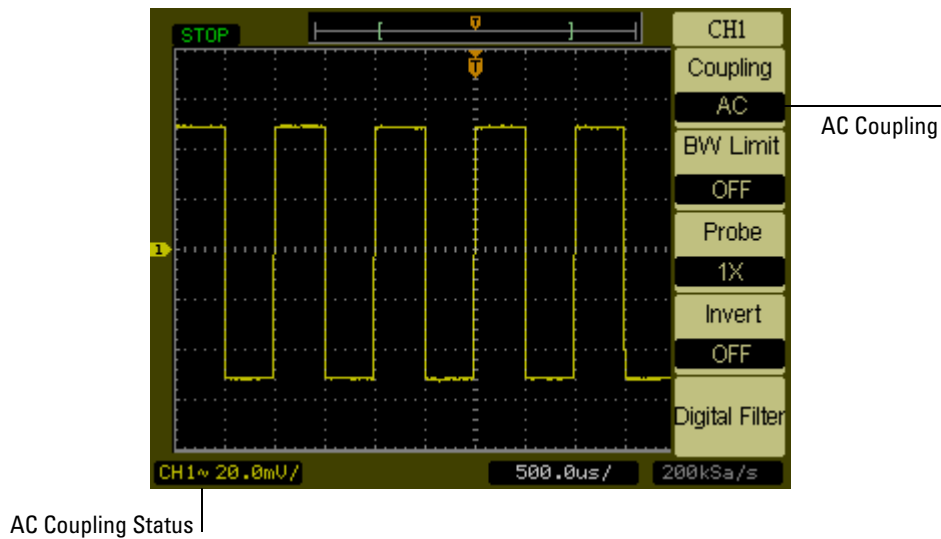
## Channel Coupling Control

The channel coupling control can be used to remove any DC offset voltage on a waveform. By setting the coupling control to **AC** the DC offset voltage is removed from the input waveform.

To remove any DC offset voltage from a waveform on channel 1, press the **1** front panel key. Press the Coupling menu key until **AC** appears.

See Figure 2-2.

**Figure 2-2**

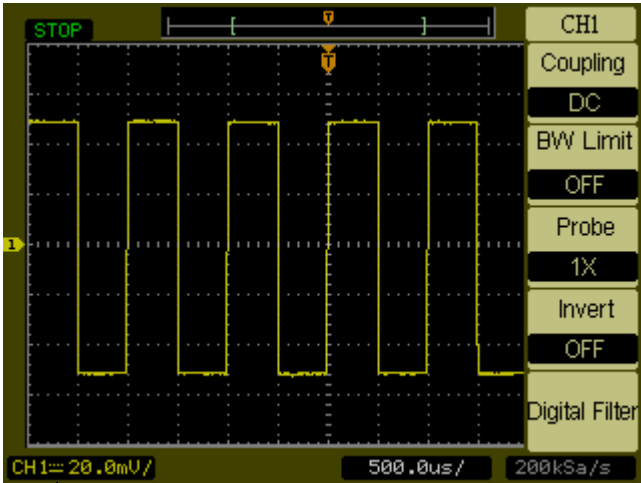


### **AC Coupling Control**

When **DC** coupling is selected, both AC and DC components of the input waveform are passed to the oscilloscope. See Figure 2-3.



Figure 2-3



DC Coupling

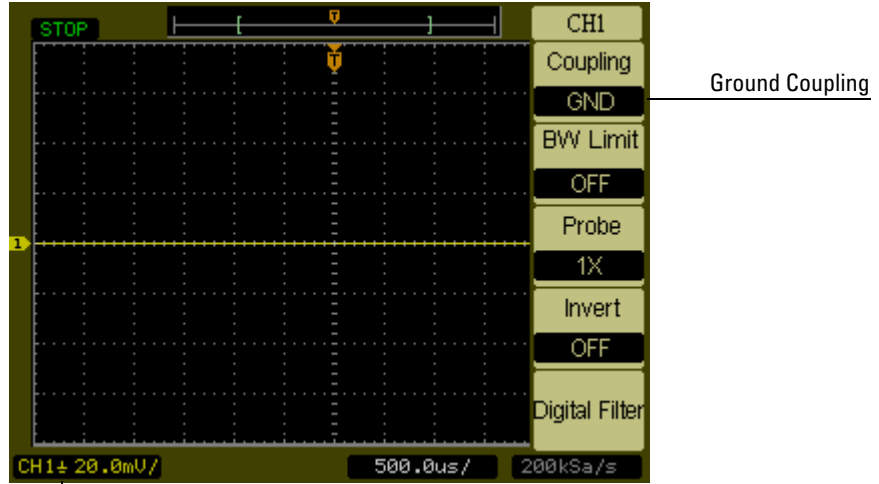
DC Coupling Status |

**DC Coupling Control**

Vertical Controls  
**Channel Coupling Control**

When **GND** coupling is selected, the waveform is disconnected from the oscilloscope input. See Figure 2-4.

**Figure 2-4**



Ground Coupling Status |

**GND Coupling Control**

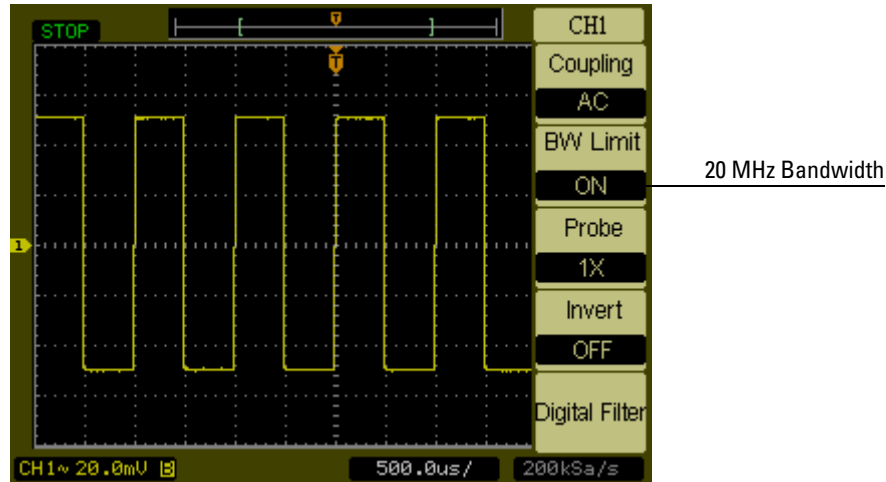
---

## Bandwidth Limit Control

The bandwidth limit control can be used to remove high frequency components on a waveform that are not important to the analysis of the waveform.

To remove high frequency components from a waveform on channel 1, press the **1** front panel key. Press the **BW Limit** menu key until **ON** appears. Frequencies above 20 MHz will be rejected. See Figure 2-5.

**Figure 2-5**

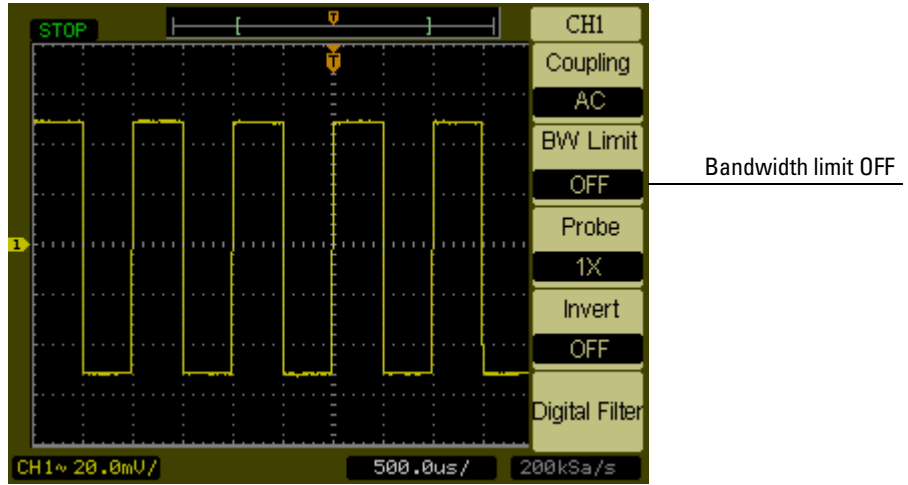


Bandwidth Limit ON Status

### **BW Limit Control ON**

When the **BW Limit** control is set to **OFF**, the oscilloscope is set to full bandwidth. See Figure 2-6.

Figure 2-6



**BW Limit Control OFF**

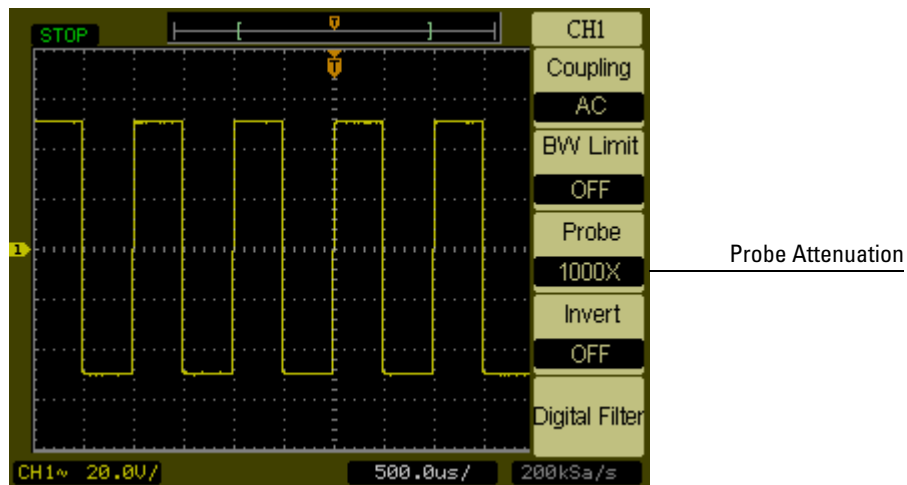
## Probe Attenuation Control

The probe attenuation control changes the attenuation factor for the probe. The attenuation factor changes the vertical scaling of the oscilloscope so that the measurement results reflect the actual voltage levels at the probe tip.

To change the probe attenuation factor for channel 1, press the **1** front panel key. Press the **Probe** menu key to change the attenuation factor to match the probe being used.

Figure 2-7 shows an example for using a 1000:1 probe.

**Figure 2-7**



**Probe Attenuation Set to 1000:1**

**Table 2-1**

**Probe attenuation factors and corresponding settings**

1:1	1X
10:1	10X
100:1	100X
1000:1	1000X

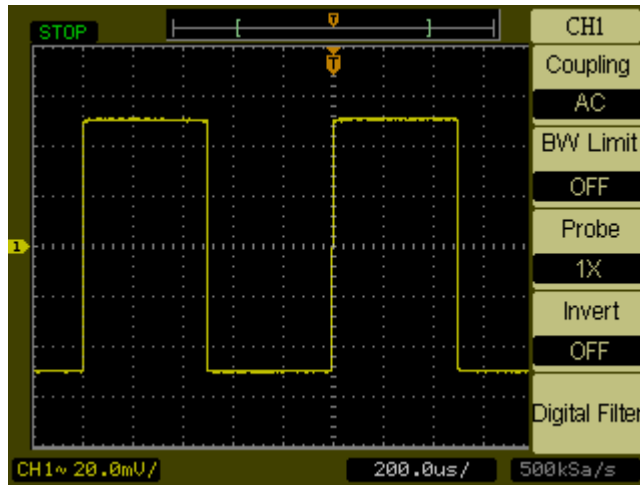
## Invert Control

The invert control inverts the displayed waveform with respect to the ground level. When the oscilloscope is triggered on the inverted waveform, the trigger is also inverted.

To invert the waveform on channel 1, press the **1** front panel key. Press the **Invert** menu key until ON appears.

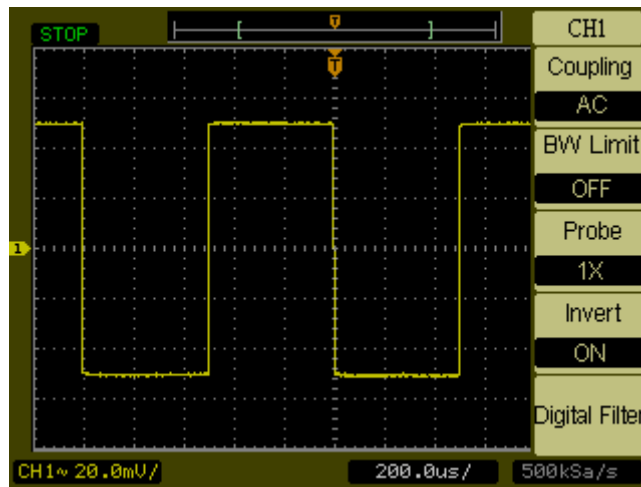
Figure 2-8 and Figure 2-9 show the changes before and after inversion.

**Figure 2-8**



**The waveform before inversion.**

**Figure 2-9**



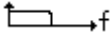
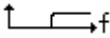
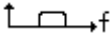
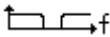


**The waveform after inversion.**

---

## Digital Filter Controls

Pressing the **Digital Filter** menu key displays the **Filter** Controls. The filter controls set the digital filter used to filter the sampled waveform data. The types of filters that are available are shown in Table 2-2.

**Table 2-2**

<b>Filter Menu</b>		
<b>Menu</b>	<b>Setting</b>	<b>Description</b>
Digital Filter	<b>ON</b> <b>OFF</b>	Turns the filter for this channel on and off
Filter Type		LPF (Low Pass Filter)
		HPF (High Pass Filter)
		BPF (Band Pass Filter)
		BRF (Band Reject Filter)
Upper Limit		The front panel entry knob sets the high limit
Lower Limit		The front panel entry knob sets the low limit

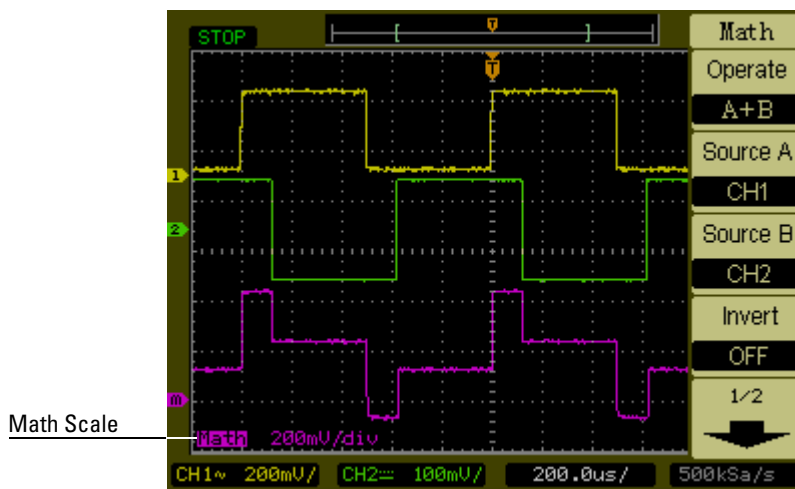
Pressing the **Upper Limit** or the **Lower Limit** menu keys turns the front panel entry knob into a control that can set the high and low frequency limits of the digital filter. The horizontal scale control determines the maximum value for the upper and lower limits.



## Math Functions Control

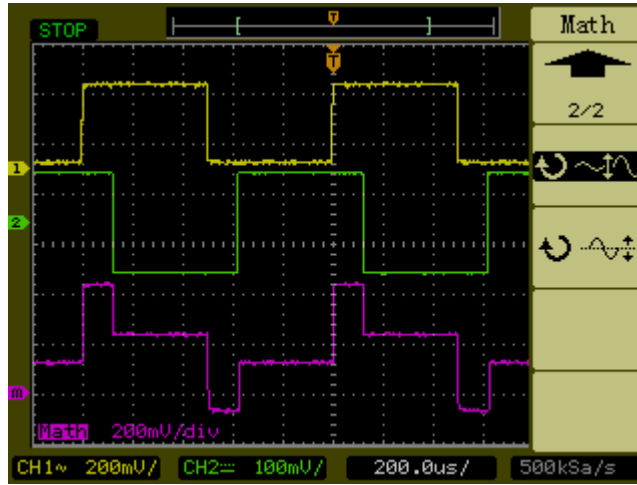
The math functions control allows the selection of the math functions add, subtract, multiply, and FFT (Fast Fourier Transform) for **CH1** and **CH2**. The mathematical result can be measured visually and also using the cursor controls. To select a math function, press the **Math** button to display the **Math** menu. The settings of this menu are shown in the Table 2-3. The amplitude of the math waveform can be adjusted by pressing the **1/2** key, selecting the scaling control, and turning the entry knob. The adjustment range is in a 1-2-5 sequence from 1 mV/div to 10 kV/div. The scale setting is displayed above the status bar. The position of the math function can be similarly adjusted.

Figure 2-10



Math Function Definition

**Figure 2-11**



**Math Scale Setting**

**Table 2-3**

**Math Menu**

Menu	Settings	Description
Operation	<b>A+B</b>	Add source A to source B
	<b>A-B</b>	Subtract source B from source A
	<b>AxB</b>	Multiply source B by source A
	<b>FFT</b>	Fast Fourier Transform
Source A	<b>CH1</b> <b>CH2</b>	Set CH1 or CH2 as source A
Source B	<b>CH1</b> <b>CH2</b>	Set CH1 or CH2 as source B
Invert	<b>ON</b>	Inverted display of the Math waveform.
	<b>OFF</b>	Non-inverted display of the Math waveform.

**Using the FFT**

The FFT math function mathematically converts a time-domain waveform into its frequency components. FFT waveforms are useful for finding the harmonic content and distortion in systems, for characterizing noise in DC power supplies, and for analyzing vibration.

The FFT of a waveform that has a DC component or offset can cause incorrect FFT waveform magnitude values. To minimize the DC component, choose AC Coupling on the source waveform.

To reduce random noise and aliasing components in repetitive or single-shot waveforms, set the oscilloscope acquisition mode to averaging.

To display FFT waveforms with a large dynamic range, use the dBVrms scale. The dBVrms scale displays component magnitudes using a log scale.

**Selecting an FFT Window**

There are 4 FFT windows. Each window has trade-offs between frequency resolution and amplitude accuracy. Your source waveform characteristics along with your measurement priorities help determine which window to use. Use the following guidelines to select the best window.

**Table 2-4**

<b>FFT Windows</b>		
<b>Window</b>	<b>Characteristics</b>	<b>Best for measuring</b>
Rectangle	Best frequency resolution, worst magnitude resolution. This is essentially the same as no window.	Symmetric transients or bursts. Equal-amplitude sine waves with fixed frequencies. Broadband random noise with a relatively slowly varying spectrum.
Hanning and Hamming	Better frequency, poorer magnitude accuracy than Rectangular. Hamming has slightly better frequency resolution than Hanning.	Sine, periodic, and narrow-band random noise. Asymmetric transients or bursts.
Blackman	Best magnitude, worst frequency resolution.	Single frequency waveforms, to find higher order harmonics.

Key points

The FFT resolution is the quotient of the sampling rate and the number of FFT points. With a fixed number of FFT points, the lower the sampling rate the better the resolution.

The Nyquist frequency is the highest frequency that any real-time digitizing oscilloscope can acquire without aliasing. This frequency is half that of the sample rate, provided it is within the analog bandwidth of the oscilloscope. Frequencies above the Nyquist frequency will be under sampled, which causes aliasing.

## Reference Control

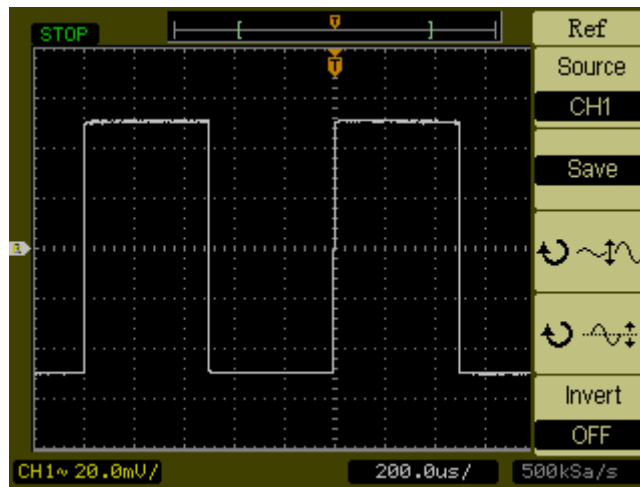
The reference control saves waveforms to a nonvolatile waveform memory. The reference function becomes available after a waveform has been saved.

To display the reference waveform menu, press the **Ref** button.

Table 2-5

Ref Menu		
Menu	Settings	Comments
Source	<b>CH1</b> <b>CH2</b>	Select channel for the reference memory.
Save		Save selected source waveform into nonvolatile waveform memory.
Invert	<b>ON</b> <b>OFF</b>	Inverted display of the reference waveform. Non-inverted display of the reference waveform.

Figure 2-12



Ref Menu

**Saving a Reference Waveform.**

- 1** Push the **Ref** button to show the reference waveform menu.
- 2** Set the Source to **CH1** or **CH2** to select the channel you want.
- 3** Press **Save** to save the selected channel into the reference memory.

The reference function is not available in X-Y mode.

You cannot adjust the horizontal position and scale of the reference waveform.

## Removing Waveforms from the Display

The channel 1 and channel 2 waveforms are turned on and off by pressing the **1** and **2** buttons on the front panel. The math functions and reference waveforms are similarly turned on and off by pressing the **Math** and **Ref** buttons on the front panel.

---

## Horizontal Controls

The oscilloscope shows the time per division in the status bar. Since all waveforms use the same time base, the oscilloscope only displays one value for all channels, except when you use Delayed Sweep. The horizontal controls can change the horizontal scale and position of waveforms. The horizontal center of the screen is the time reference for waveforms. Changing the horizontal scale causes the waveform to expand or contract around the screen center. The horizontal position knob changes the position of the trigger point relative to the center of the screen.

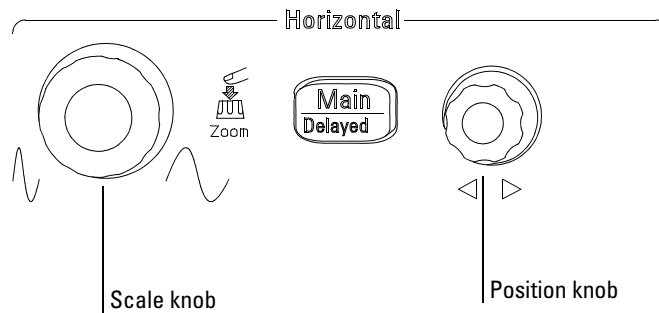


---

## Horizontal System Setup

Figure 2-13 shows the front panel horizontal system controls.

**Figure 2-13**



### Horizontal Controls

The following exercise guides you through these buttons, knobs, and status bar.

- 1 Turn the scale knob and notice the change it makes to the status bar.**  
The scale knob changes the sweep speed in a 1-2-5 step sequence and the value is displayed in the status bar.
- 2 Turn the position knob to move the trigger point with respect to the center of the screen.**
- 3 Press the **Main/Delayed** key to display the associated menu.**  
In this menu, you can enter or exit the Delayed Sweep mode, set the display to Y-T or X-Y format, and alter the **Trig-Offset** and **Holdoff** values.

Pressing the horizontal scale knob is another way to enter or exit the delayed sweep mode.

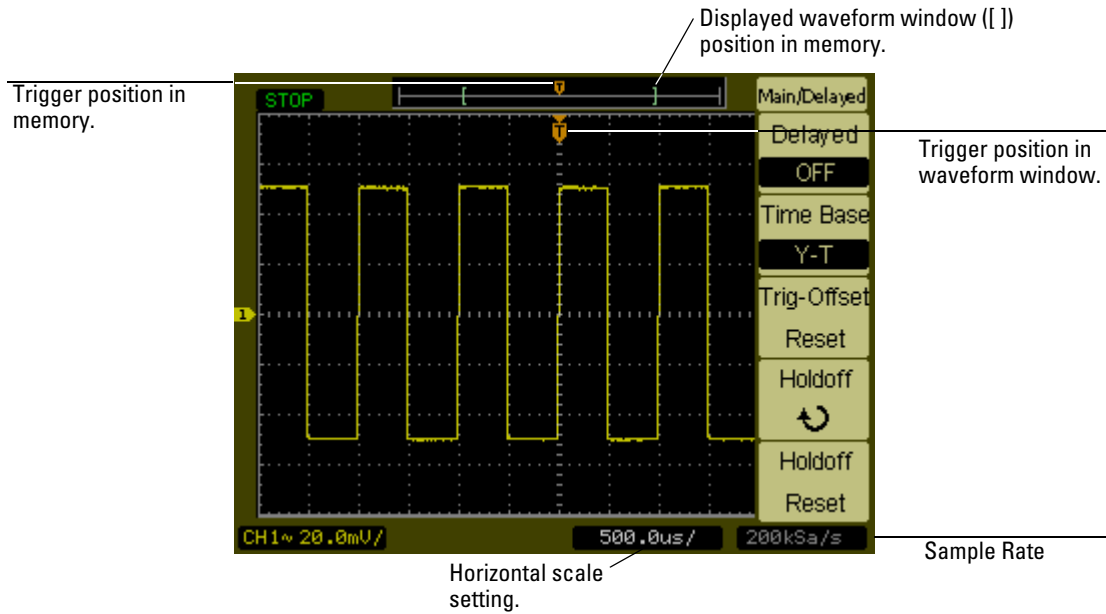
## Horizontal Knobs

The position knob adjusts the horizontal position of all channels and math functions. The resolution of this control varies with the time base. The oscilloscope digitizes waveforms by acquiring the value of an input waveform at discrete points. The time base allows you to control the sampling rate of this digitizing process. The horizontal scale control changes the horizontal time/div of the main time base. When delayed sweep is enabled, the horizontal scale control changes the width of the delayed sweep window.

## Horizontal Menu

Pressing the Main/Delayed button displays the associated menu. Figure 2-14 shows the screen icon descriptions and control indicators.

**Figure 2-14**



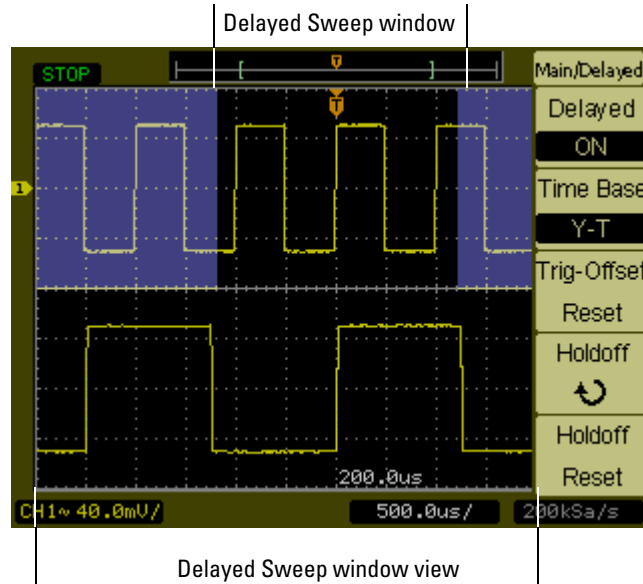
### Status bar, trigger position, and horizontal scale controls indicators

#### Delayed Sweep

The Delayed Sweep is used to magnify a portion of the main waveform window. You can use Delayed Sweep to locate and horizontally expand part of the main waveform window for a more detailed (higher horizontal resolution) analysis of the waveform.

The Delayed Sweep time base setting cannot be set slower than the Main time base setting.

Figure 2-15



#### Delayed Sweep Window

The screen is divided into two parts. The top half of the display shows the main waveform window. The bottom half of the displays shows an expanded view of the main waveform window. This expanded portion of the main window is called the Delayed Sweep window. Two blocks shadow the top half, the unshadowed portion is expanded in the lower half.

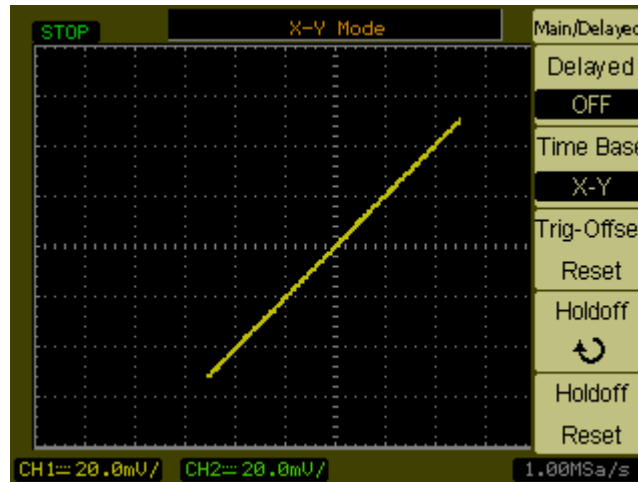
In this mode, the horizontal position and scale knobs control the size and position of the Delayed Sweep window. To change the Main time base, you must turn off the Delayed Sweep mode. Since both the Main and Delayed Sweep windows are displayed, there are half as many vertical divisions so the vertical scaling is doubled. Notice the changes in the status bar.

The Delayed Sweep function can also be activated by pressing the horizontal scale knob.

### X-Y Format

This format compares the voltage levels of two waveforms point by point. It is useful for studying phase relationships between two waveforms. This format only applies to channels 1 and 2. Choosing the X-Y display format displays channel 1 on the horizontal axis and channel 2 on the vertical axis. The oscilloscope uses the untriggered acquisition mode and waveform data is displayed as dots. The sampling rate can vary from 2 kSa/s to 100 MSa/s, and the default sampling rate is 1 MSa/s.

Figure 2-16



### X-Y display format

The following modes or functions are not available in X-Y format.

- Automatic Measurements
- Cursor Measurements
- Mask Test
- **Ref** and **Math** Operations
- Delayed Sweep
- Vector Display Mode
- Horizontal position knob
- Trigger Controls

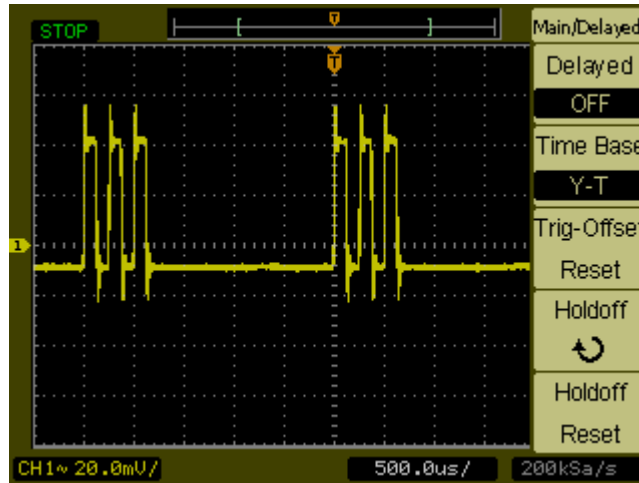
### Trig-Offset Reset

This control resets the horizontal position to center screen or zero trigger offset.

### Holdoff

Holdoff can be used to stabilize a waveform. The holdoff time is the oscilloscope's waiting period before starting a new trigger. During the holdoff time oscilloscope will not trigger until the holdoff has expired.

**Figure 2-17**



### Holdoff

The following exercise guides you through setting the holdoff time.

- 1** Press the **Main/Delayed** front panel button to display the associated menu.
- 2** Select the **Holdoff** menu button.
- 3** Adjust the entry knob to change the Holdoff time until the waveform is stable.
- 4** Press the **Holdoff Reset** menu button to change the Holdoff time to the 100 ns minimum value.

---

## Roll Mode

Roll mode continuously moves data across the display from left to right. It allows you to see dynamic changes (like adjusting a potentiometer) on low frequency waveforms. Two frequently used applications are transducer monitoring and power supply testing. When in the Roll Mode, the oscilloscope is untriggered and runs continuously. You can also make automatic measurements in the roll mode.

The oscilloscope automatically enters the Roll Mode when the Horizontal **Scale** control is set to 50 ms/div or slower and the trigger sweep is set to Auto.

---

# Trigger Controls

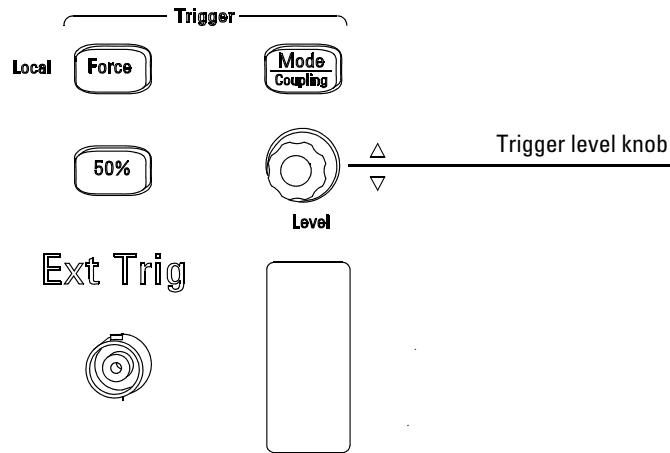
The trigger determines when the oscilloscope starts to acquire data and display a waveform. When a trigger is set up properly, it can convert unstable displays or blank screens into meaningful waveforms. The oscilloscope acquires data while waiting for the trigger condition to occur. After it detects a trigger, the oscilloscope continues to acquire enough data so that it can draw the waveform on the display.



## Trigger System Setup

Figure 2-18 shows the front panel trigger system controls.

**Figure 2-18**

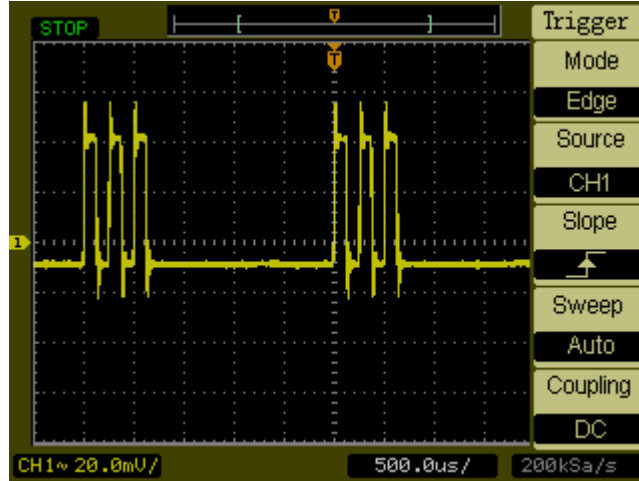


### Trigger Controls

The following exercise guides you through these trigger buttons, knobs, and status bar.

- 1** Turn the trigger **Level** knob and notice the changes it makes to the display.  
 As you turn the **Level** knob two things happen on the display. First, the trigger level value is displayed at the lower left-hand corner of the screen. Second, if the trigger coupling is **DC** or **HF Reject**, a line is displayed showing the location of the trigger level with respect to the waveform.
- 2** Change the trigger setup and notice how these changes affect the status bar.
  - a** Press the **Mode/Coupling** button in the trigger controls area. The Trigger menu appears. Figure 2-19 displays this trigger menu.

Figure 2-19



**Trigger Menu**

- b** Press the **Mode** menu button and notice the differences between **Edge** trigger, **Pulse** trigger, and **Video** trigger. Leave in the **Edge** mode.
  - c** Press the trigger **Slope** menu button to notice the differences between rising edge and falling edge.
  - d** Press the trigger **Source** menu button to select trigger source choices.
  - e** Press the **Sweep** button to select **Auto** or **Normal**.
  - f** Press the **Coupling** menu button and notice how **AC**, **DC**, **LF Reject**, and **HF Reject** affect the waveform display.
- 3** Press the **50%** key and observe that the trigger level is set to the center of the waveform.
- 4** Press the **Force** button to start an acquisition even if a valid trigger has not been found. This button has no effect if the acquisition is already stopped.

The **Force** button has another function called **Local** when the oscilloscope is being remotely controlled. When the oscilloscope is being remotely controlled, the front panel keys are disabled. By pressing the **Force (Local)** key, the oscilloscope front panel keys will be reenabled.

---

## Trigger Modes

The oscilloscope provides three trigger modes: edge, pulse, and video. Edge trigger can be used with analog and digital circuits. An edge trigger occurs when the trigger input passes through a specified voltage level with the specified slope. Pulse trigger is used to find pulses with certain pulse widths. Video is used to trigger on fields or lines for standard video waveforms.

### Edge Trigger

The **Slope** and **Level** controls help to define the Edge trigger. The **Slope** control determines whether the oscilloscope finds the trigger point on the rising or the falling edge of a waveform. The **Level** control determines voltage point on the waveform where the trigger occurs.

**Table 2-6**

**Edge Trigger Menu Buttons**

Menu	Settings	Comments
Source	<b>CH1</b>	Sets <b>CH1</b> as the trigger source
	<b>CH2</b>	Sets <b>CH2</b> as the trigger source
	<b>EXT</b>	Sets EXT TRIG as the trigger source
	<b>EXT/5</b>	Sets EXT TRIG/5 as the trigger source
	<b>AC Line</b>	Sets the power line as the trigger source
Slope	<b>Rising</b>	Trigger on rising edge
	<b>Falling</b>	Trigger on falling edge
Sweep	<b>Auto</b>	Acquire waveform even when no trigger occurs
	<b>Normal</b>	Acquire waveform when trigger occurs.
Coupling	<b>AC</b>	Sets the input coupling to AC (50 Hz cutoff)
	<b>DC</b>	Sets the input coupling to DC
	<b>LF Reject</b>	Sets the input coupling to low frequency reject (100 kHz cutoff)
	<b>HF Reject</b>	Sets the input coupling to high frequency reject (10 kHz cutoff)








## Trigger Controls

### Trigger Modes

#### Pulse Trigger

A pulse trigger occurs when a pulse is found in a waveform that matches the pulse definition. The **When** and **Setting** menu buttons control the pulse definition.



Table 2-7

Pulse Trigger Menu Buttons		
Menu	Settings	Comments
Source	<b>CH1</b>	Sets channel 1 as the trigger source
	<b>CH2</b>	Sets channel 2 as the trigger source
	<b>EXT</b>	Sets EXT TRIG as the trigger source
	<b>EXT/5</b>	Sets EXT TRIG/5 as the trigger source
When		Positive pulse width less than pulse width setting
		Positive pulse width larger than pulse width setting
		Positive pulse width equal to pulse width setting
		Negative pulse width less than pulse width setting
		Negative pulse width larger than pulse width setting
		Negative pulse width equal to pulse width setting
Setting	 <Width>	Adjusts pulse width using the front panel entry knob
Sweep	<b>Auto</b>	Acquire waveform even when no trigger occurs
	<b>Normal</b>	Acquire waveform when trigger occurs
Coupling	<b>AC</b>	Sets the input coupling to AC (50 Hz cutoff)
	<b>DC</b>	Sets the input coupling to DC
	<b>HF Reject</b>	Sets the input coupling to low frequency reject (100 kHz cutoff)
	<b>LF Reject</b>	Sets the input coupling to high frequency reject (10 kHz cutoff)

#### Video Trigger

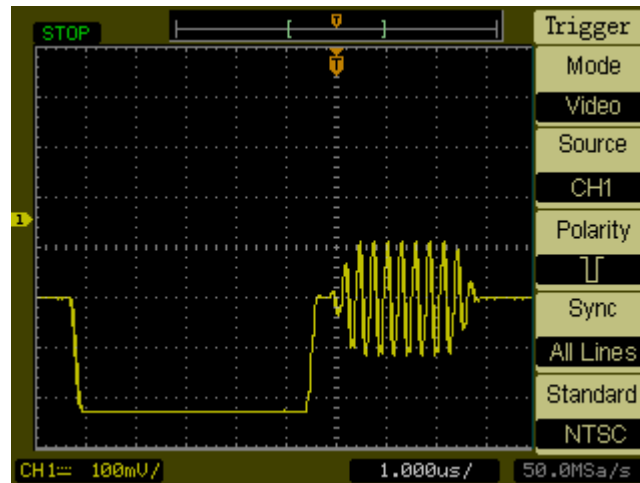
Video triggering is used to trigger on fields or lines of NTSC, PAL, or SECAM standard video waveforms. When **Video** is selected, the trigger coupling is set to **AC**.

**Table 2-8**

Video Trigger Menu Buttons		
Menu	Settings	Comments
Source	<b>CH1</b> <b>CH2</b> <b>EXT</b> <b>EXT/5</b>	Sets <b>CH1</b> as the trigger waveform Sets <b>CH2</b> as the trigger waveform Sets EXT TRIG as the trigger waveform Sets EXT TRIG/5 as the trigger waveform
Polarity	 <b>Normal polarity</b>	Trigger on the negative edge of the sync pulse
	 <b>Inverted polarity</b>	Trigger on the positive edge of the sync pulse
Sync	<b>All Lines</b> <b>Line Num</b> <b>Odd field</b> <b>Even field</b>	Trigger on all lines Trigger on a selected line Trigger on an odd field Trigger on an even field
Standard	<b>PAL/SECAM</b> <b>NTSC</b>	Trigger on a PAL or SECAM video waveform Trigger on an NTSC video waveform

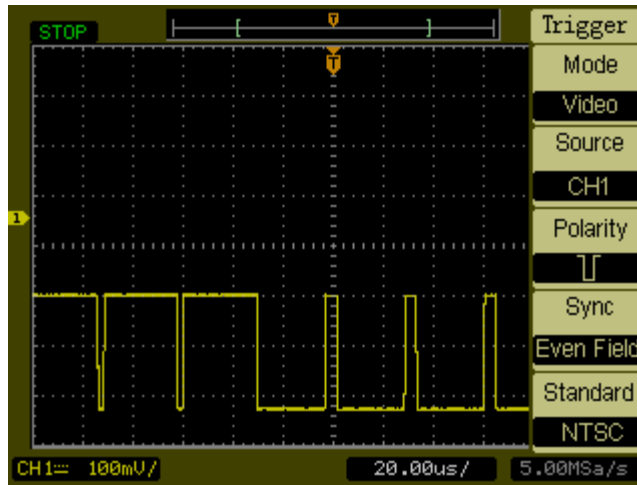
Normal Polarity Sync triggers always occur on negative-going horizontal sync pulses. If the video waveform has positive-going horizontal sync pulses, use the Inverted Polarity selection.

**Figure 2-20**



**Video Line Trigger**

Figure 2-21



Video Field Trigger

---

# Waveform Controls

Figure 2-22 shows the location of the **Acquire** button in the **Waveform** section of the front panel.

**Figure 2-22**



## Waveform Controls

Pressing the **Acquire** button displays the **Acquire** menu as follows:

**Table 2-9**

Menu	Settings	Comments
Mode	<b>Normal</b> <b>Average</b> <b>Peak Detect</b>	Normal acquisition mode Average acquisition mode Peak Detect acquisition mode
Sampling	<b>Real Time</b> <b>Equ-Time</b>	Real time sampling mode Equivalent time sampling mode
Averages	<b>2 to 256</b>	Step by multiple of two. Set average counts from 2 to 256
Sequence		Activate sequential capture, store, and playback

Select **Real Time** sampling to observe single-shot or pulse waveforms.  
Select **Equ-Time** sampling to observe high frequency repetitive waveforms.  
To reduce the displayed random noise, select the **Average** acquisition. This mode decreases screen refresh rate.  
To avoid waveform aliasing, select **Peak Detect** acquisition.

## Stop Acquisition

When acquisition is stopped, the last acquired waveform is displayed. The waveform can be moved by using the vertical and horizontal controls. When the horizontal scale is set to 20 ns or faster, the oscilloscope uses sine(x)/x interpolation to expand the horizontal signal resolution.

---

## Equivalent Time Sampling

The equivalent time sampling mode can achieve up to 20 ps of horizontal resolution (equivalent to 50 GSa/s). This mode is good for observing repetitive waveforms and should not be used for single-shot events or pulse waveforms.

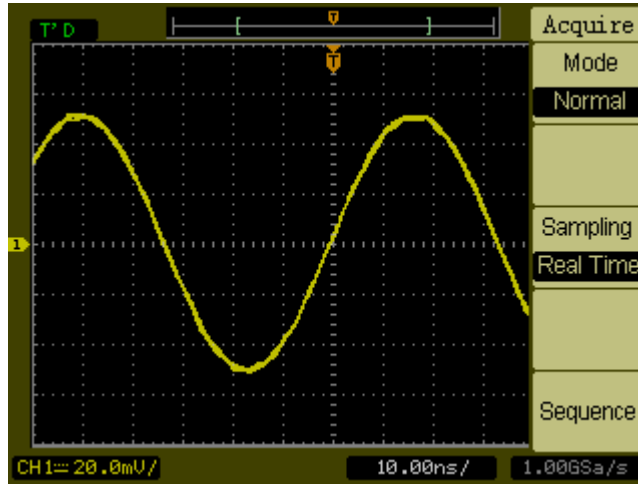
---

## Average Acquisition

The Average Acquisition mode should be used to remove random noise from the waveform and to improve measurement accuracy. See Figure 2-23 and Figure 2-24. The averaged waveform is a running average over a specified number of acquisitions from 2 to 256.

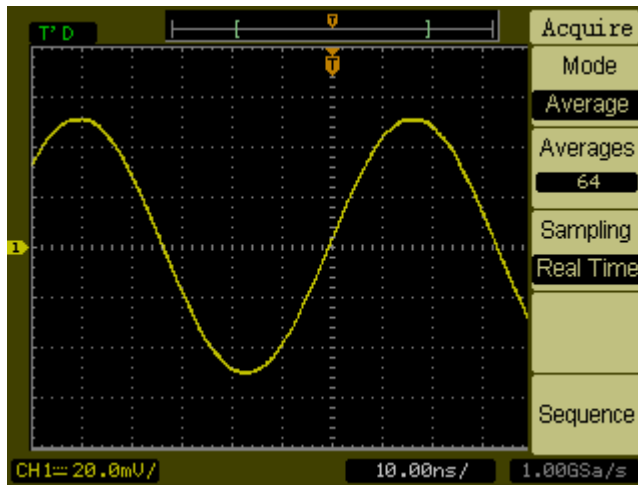


Figure 2-23



Noisy Waveform Without Averaging

Figure 2-24



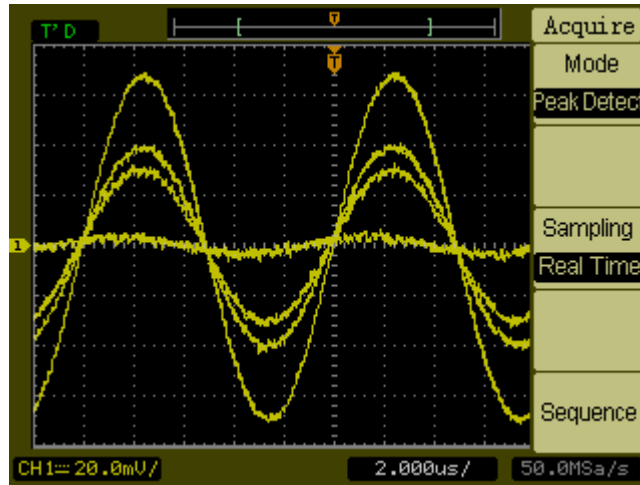
Noisy Waveform With Averaging

---

## Peak Detect

Peak Detect mode captures the maximum and minimum values of a waveform over multiple acquisitions.

Figure 2-25



Peak Detect Waveform

## Sequence Capability

The sequence capability or waveform recorder can record input waveforms from channel 1 or channel 2, with a maximum acquisition depth of 1000 frames. This recording behavior can also be activated by the Mask Test, which makes this function especially useful for capturing abnormal waveforms over a long period of time.

Pressing the **Sequence** key produces the associated menu as follows:

**Table 2-10**





<b>Sequence Menu</b>		
<b>Menu</b>	<b>Settings</b>	<b>Comments</b>
Mode	<b>Capture</b> <b>Play back</b> <b>Save/Recall</b> <b>Off</b>	Select capture mode Select play back mode Select storage mode Turn off all sequence functions
Source	<b>CH1</b> <b>CH2</b>	Select capture source channel
Interval	 <1.00ms-1000s>	Set time interval between captured frames using the entry knob
End Frame	 <1-1000>	Set number of captured frames using the entry knob
Operate	 (Record)  (Stop)	Press to start capturing Press to stop capturing

Table 2-11





Playback Menu 1		
Menu	Settings	Comments
Operation	 (Play)	Press to start playback
	 (Stop)	Press to stop playback
Msg Display	On	Turn on recorder information display
	Off	Turn off recorder information display
Play mode		Set continuous play mode
		Set one time play mode

Table 2-12







Playback Menu 2		
Menu	Settings	Comments
Interval	 <1.00 ms to 20s>	Set time interval between frames using the front panel entry knob
Start frame	 <1 to 1000>	Set start frame using the front panel entry knob
Current frame	 <1 to 1000>	Select current frame to be played using the front panel entry knob
End frame	 <1 to 1000>	Set End frame using the front panel entry knob

Table 2-13

Save/Recall Menu		
Menu	Settings	Comments
Start frame	 <1 to 220>	Set first frame to be saved using the front panel entry knob
End frame	 <1 to 220>	Set last frame to be saved using the front panel entry knob
Save		Save the waveforms between start frame and end frame
Load		Load the saved waveforms from non-volatile memory

---

# Display Controls

Figure 2-26 shows location of the **Display** button in the **Waveform** area of the front panel.

**Figure 2-26**






## Display Menu

Pressing the **Display** button produces the **Display** menu as follows:



**Table 2-14**

**Display Menu 1**

Menu	Setting	Comments
Type	<b>Vectors</b>	Display waveforms as vectors
	<b>Dots</b>	Display waveforms as dots
Grid		Display grids and axes on the screen
		Turn off the grids
		Turn off the grids and axes
Persist	<b>Infinite</b>	The sample points remain displayed until persistence is set to "OFF" or Clear is pressed
	<b>OFF</b>	Turn off the persistence function
Clear		Clears waveforms from the display

When the display **Type** is set to **Vectors**, the oscilloscope connects the sample points by using digital interpolation. Digital interpolation maintains linearity by using a  $\sin(x)/x$  digital filter. The digital interpolation is suitable for real time sampling and is most effective at 20 ns or faster horizontal scale settings.

**Table 2-15**

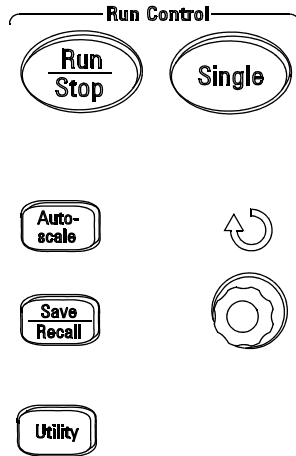
<b>Display Menu 2</b>		
<b>Menu</b>	<b>Settings</b>	<b>Comments</b>
		Press to increase display brightness
		Press to decrease display brightness
Menu Display	<b>1s, 2s, 5s, 10s, 20s, and Infinite</b>	Sets the time before hiding menus
Screen	<b>Normal</b>	Sets to normal display colors
	<b>Invert</b>	Sets to inverted display colors

---

# Save and Recall Controls

Figure 2-27 shows the location of the **Save/Recall** button on the front panel.

**Figure 2-27**



## Save/Recall Button Location

Pressing the **Save/Recall** button produces the associated menu as follows:

**Table 2-16**

Save/Recall Menu Buttons		
Menu	Settings	Comments
Save/Recall	<b>Waveforms</b> <b>Setups</b>	Save or recall waveforms Save or recall an oscilloscope setup
Default Setup		Loads the factory default setup
Waveform	<b>No.1</b> through <b>No. 10</b>	Sets the storage location of the waveform
Setup	<b>No.1</b> through <b>No. 10</b>	Sets the storage location of the setup
Load		Recall waveforms or setups
Save		Save waveforms or setups

---

## Waveforms

You can save 10 waveforms for the two channels in the nonvolatile memory of the oscilloscope and overwrite the previously saved contents as needed.

---

## Setups

You can save 10 settings in the nonvolatile memory of the oscilloscope and overwrite previously saved setups. By default, the oscilloscope saves the current setup each time it is turned off. The oscilloscope automatically recalls this setup the next time it is turned on.

---

## Default Setup

You can recall the factory default setup any time you want to return the oscilloscope to the state it was in when you received it.

---

## Load

The saved waveforms or setups can be recalled by pressing the **Load** menu button.

---

## Save

Either the waveforms or the current settings of the oscilloscope are saved to nonvolatile memory by pressing the **Save** menu button. Wait at least five seconds before turning off the oscilloscope after pressing this button.

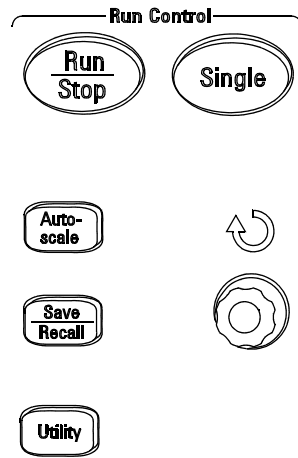


---

# Utility Controls

Figure 2-28 shows the location of the **Utility** button on the front panel.



**Figure 2-28**



## Utility Button

Pressing the **Utility** button produces the associated menu as follows:

**Table 2-17**

<b>Utility Menu 1</b>		
<b>Menu</b>	<b>Setting</b>	<b>Comments</b>
Mask Test		Setup Mask Test
I/O Setup		Produces the I/O Setup menu
Language	<b>English</b> <b>German</b> <b>French</b> <b>Italian</b> <b>Russian</b> <b>Portuguese</b> <b>Simplified Chinese</b> <b>Traditional Chinese</b> <b>Korean</b> <b>Japanese</b>	Select language (More languages may be added in later software versions)
Sound	 (ON)	Switches the beeper sound on or off
	 (OFF)	

**Table 2-18**

<b>Utility Menu 2</b>	
<b>Menu</b>	<b>Comments</b>
System Info	Displays model number, serial number, and software version information
Self-Cal	Execute Self-calibration
Self-Test	Execute Self-test

## Mask Test

The Mask Test function monitors waveform changes by comparing the waveform to a predefined mask.

Pressing the **Mask Test** key produces the following menu:

Table 2-19







Mask Test Menu 1		
Menu	Setting	Comments
Enable Test	<b>On</b>	Turn on Mask Test
	<b>Off</b>	Turn off Mask Test
Source	<b>CH1</b>	Select Mask Test on <b>CH1</b>
	<b>CH2</b>	Select Mask Test on <b>CH2</b>
Operation	 (Run)	Mask Test stopped, press to run
	 (Stop)	Mask Test running, press to stop
Msg Display	<b>On</b>	Turn on Mask Test information display
	<b>Off</b>	Turn off Mask Test information display

Table 2-20

Mask Test Menu 2		
Menu	Settings	Comments
Output	<b>Fail</b>	Indicate when Fail condition detected
	<b>Fail +</b> 	Indicate and beep when Fail condition detected
	<b>Pass</b>	Indicate when Pass condition detected
	<b>Pass +</b> 	Indicate and beep when Pass condition detected
Stop on Output	<b>On</b>	Stop when output condition occurs
	<b>Off</b>	Continue when output condition occurs
Load		Load a previously stored mask

**Table 2-21**

<b>Mask Test Menu 3</b>		
<b>Menu</b>	<b>Settings</b>	<b>Comments</b>
X Mask	 < x div >	Set the mask's horizontal failure margin (0.04 div to 4.00 div)
Y Mask	 < y div >	Set the mask's vertical failure margin (0.04 div to 4.00 div)
Create Mask		Create a mask from the current waveform using the above failure margins
Save		Save the created mask

The Mask Test function is unavailable in X-Y mode .

The Output function is available on a BNC connector that is part of the optional I/O module.

---


## I/O Setup Menu

Requires the I/O module to be installed before the GPIB and RS-232 ports can be configured.

Before installing or uninstalling the I/O module, make sure that the oscilloscope power is off. More details can be found in the Programmer's Guide on the CD-ROM.

Pressing the **I/O Setup** menu key produces the following menu.

**Table 2-22**

<b>I/O Setup Menu</b>		
<b>Menu</b>	<b>Settings</b>	<b>Comments</b>
RS-232 Baud	<b>300</b> <b>2400</b> <b>4800</b> <b>9600</b> <b>19200</b> <b>38400</b>	Sets the RS-232 baud rate
GPIB Address	<b>0 through 30</b>	Sets the GPIB address
		USB connected

## System Info

Press this menu button to display the oscilloscope's model number, serial number, software version, and installed module information.

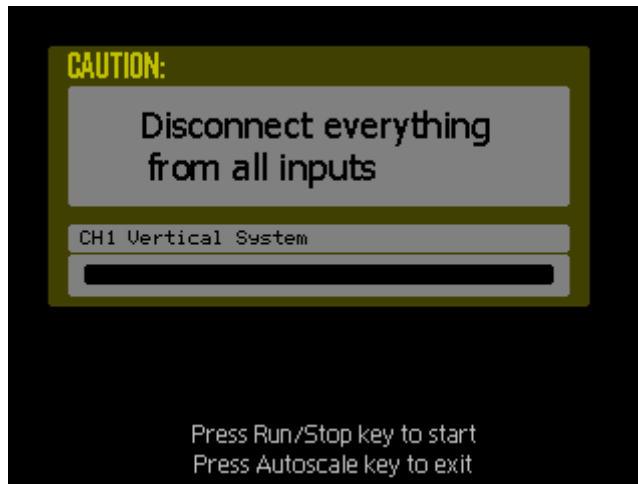
---

## Self-Calibration

Before performing the automatic calibration, allow the oscilloscope to warm-up at least 30 minutes.

Pressing the **Self-Cal** menu key starts the automatic calibration routine which adjusts the internal circuitry of the oscilloscope for the best measurement accuracy. The the automatic calibration should be run when the ambient temperature changes by 5 °C or more.

Figure 2-29



Calibration Dialog Box

---

## Self-Test

Pressing the **Self-Test** key produces the Self-Test menu as follows:

**Table 2-23**

---

### Self-Test Menu

---

<b>Menu</b>	<b>Settings</b>
Screen Test	Press to run the screen test
Key Test	Press to run the front panel key and knob test

#### **Screen Test**

Press this menu button to run the Screen Test program. Follow the on-screen messages. The screen of the oscilloscope turns red, green and blue in sequence when pressing the **Run/Stop** front panel key. Visually check the screen for display failures.

#### **Key Test**

Pressing this menu button runs the front panel key and knob test. The on-screen shapes represent the front panel keys. The shapes with two arrows beside them represent the front panel knobs. The squares represent the knob presses for scale knobs. Test all keys and knobs and verify that all of the controls turn green. During this test, you should also verify that all the backlit buttons illuminate correctly.

To exit the key test, press the **Run/Stop** key three times in succession.



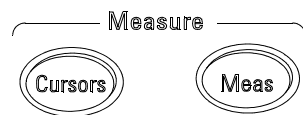
---

# Automatic Measurement Controls

The **Meas** button located on the front panel activates the automatic measurement system. The instructions below will guide you in using the various measurement functions.

Pressing the **Meas** button produces the **Measure** menu used to select automatic measurement. The oscilloscope has 20 automatic measurements: Vpp, Vmax, Vmin, Vtop, Vbase, Vamp, Vavg, Vrms, Overshoot, Preshoot, Freq, Period, Rise Time, Fall Time, Delay1-2, Delay1-2, +Width, -Width, +Duty, and -Duty. It also has a hardware counter capability.

**Figure 2-30**



**Meas Button**

**Table 2-24**

<b>Measure Menu</b>		
<b>Menu</b>	<b>Settings</b>	<b>Comments</b>
Source	<b>CH1</b> <b>CH2</b>	Selects channel 1 or channel 2 as the waveform to be measured
Voltage		Selects the voltage measurement menu
Time		Selects the time measurement menu
Clear		Clears the on screen measurement results
Display All	<b>OFF</b> <b>ON</b>	Turns off all measurements Turns on all measurements

---

## Voltage Measurements

Pressing the **Voltage** menu button produces the following menus.

**Table 2-25**

---

### Voltage Measurement Menu 1

---

<b>Menu</b>	<b>Comments</b>
Voltage 1/3	Press to display menu 2 voltage measurements
Vpp	Measure peak-to-peak voltage of a waveform
Vmax	Measure maximum voltage of a waveform
Vmin	Measure minimum voltage of a waveform
Vavg	Measure average voltage of a waveform

**Table 2-26**

---

### Voltage Measurement Menu 2

---

<b>Menu</b>	<b>Comments</b>
Voltage 2/3	Press to display menu 3 voltage measurements
Vamp	Measure voltage between Vtop and Vbase of a waveform
Vtop	Measure a flat top voltage of a waveform
Vbase	Measure a flat base voltage of a waveform
Vrms	Measure the root-mean-square voltage of a waveform

**Table 2-27**

---

### Voltage Measurement Menu 3

---

<b>Menu</b>	<b>Comments</b>
Voltage 3/3	Press to display menu 1 voltage measurements
Overshoot	Measure the overshoot voltage in percent
Preshoot	Measure the preshoot voltage in percent

---

## Time Measurements

Pressing the Time menu button produces the following menus.

**Table 2-28**

<b>Time Measurement Menu 1</b>	
<b>Menu</b>	<b>Comments</b>
Time 1/3	Press to display menu 2 time measurements
Freq	Measure the frequency of a waveform
Period	Measure the period of a waveform
Rise Time	Measure the rise time of a waveform
Fall Time	Measure the fall time of a waveform

**Table 2-29**

<b>Time Measurement Menu 2</b>	
<b>Menu</b>	<b>Comments</b>
Time 2/3	Press to display menu 3 time measurements
+Width	Measure the positive pulse width of a waveform
-Width	Measure the negative pulse width of a waveform
+Duty	Measure the positive duty cycle of a waveform
-Duty	Measure the negative duty cycle of a waveform

**Table 2-30**

<b>Time Measurement Menu 3</b>	
<b>Menu</b>	<b>Comments</b>
Time 3/3	Press to display menu 1 time measurements
Delay1→2 $\uparrow$	Measure the delay between two waveforms using the rising edges
Delay1→2 $\downarrow$	Measure the delay between two waveforms using the falling edges
Counter	Press to toggle the hardware counter on and off

The results of the automatic measurements are displayed on the bottom of the screen. When invoking individual measurements, a maximum of three results can be displayed at the same time. The next new measurement result selected moves the previous measurements to the left pushing the first measurement result off screen. The hardware counter result is displayed separately in the upper right-hand corner of the screen. The **Display All** function displays all of the measurements except for the **Delay** measurements at the same time.

## Automatic Measurement Procedure

- 1** Select either **CH1** or **CH2** according to the waveform you want to measure.
- 2** To see all time and voltage measurement values, set the **Display All** menu to **ON**.
- 3** Select the **Voltage** or **Time** menu button to display the list of measurements.
- 4** Select the desired measurement menu button. The measurement result is displayed at the bottom of the screen. If the measurement result is displayed as "\*\*\*\*\*", then the measurement cannot be performed with the current oscilloscope settings.
- 5** Press the **Clear** menu button to remove the individual automatic measurements from the screen.

---

## Measurement Concepts

This section describes the way that the automatic measurements are made.

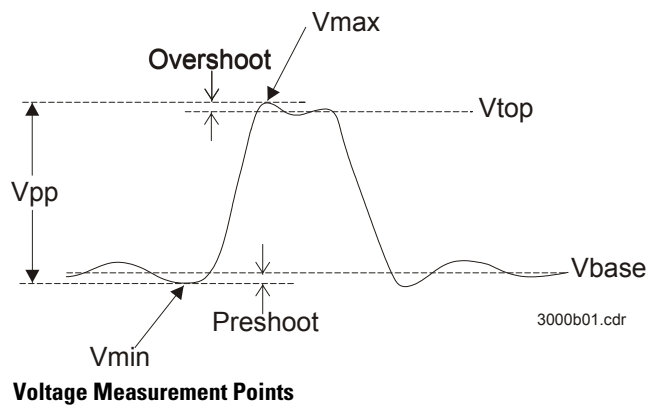
### Voltage Measurements

There are 10 automatic voltage measurements:

- Vpp (Peak-to-Peak Voltage)
- Vmax (Maximum Voltage)
- Vmin (Minimum Voltage)
- Vavg (Average Voltage)
- Vamp (Amplitude Voltage =  $V_{top} - V_{base}$ )
- Vtop (Top Voltage)
- Vbase (Base Voltage)
- Vrms (True Root-Mean-Square Voltage)
- Overshoot
- Preshoot

Figure 2-31 shows the voltage measurement points.

**Figure 2-31**



**Time Measurements**

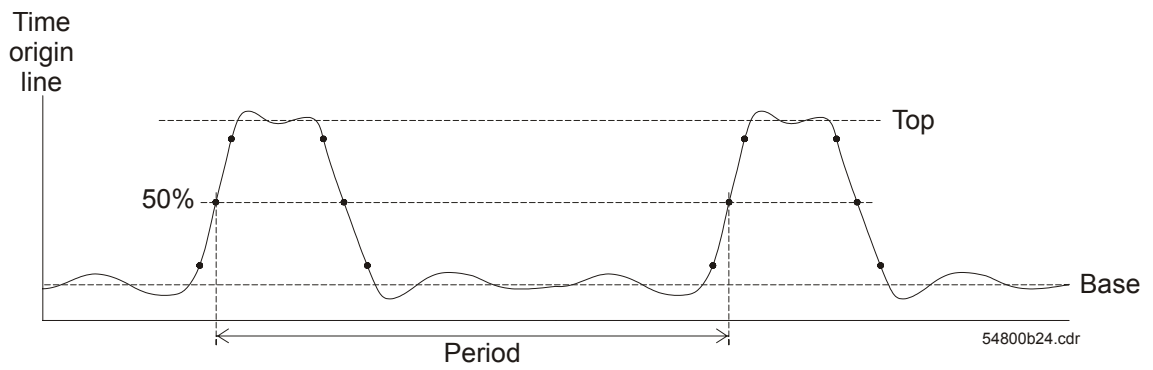
There are 10 automatic time measurements:

- Frequency
- Period
- Rise Time
- Fall Time
- +Width
- -Width
- +Duty
- -Duty
- Delay 1→2  $f$
- Delay 1→2  $t$

The following figures show how the different time measurements are made.

**Figure 2-32**

Frequency = 1/Period



**Frequency and Period Measurements**

Figure 2-33

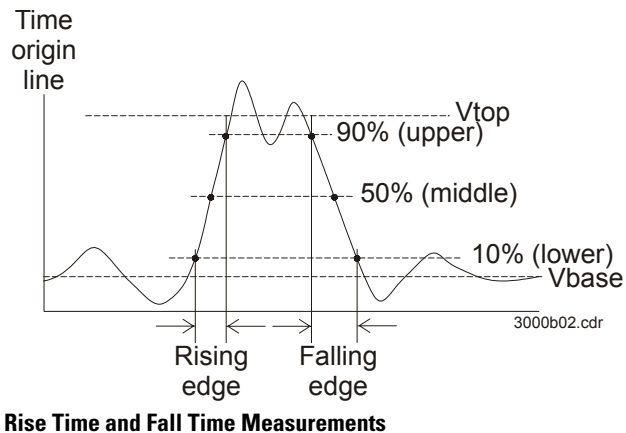


Figure 2-34

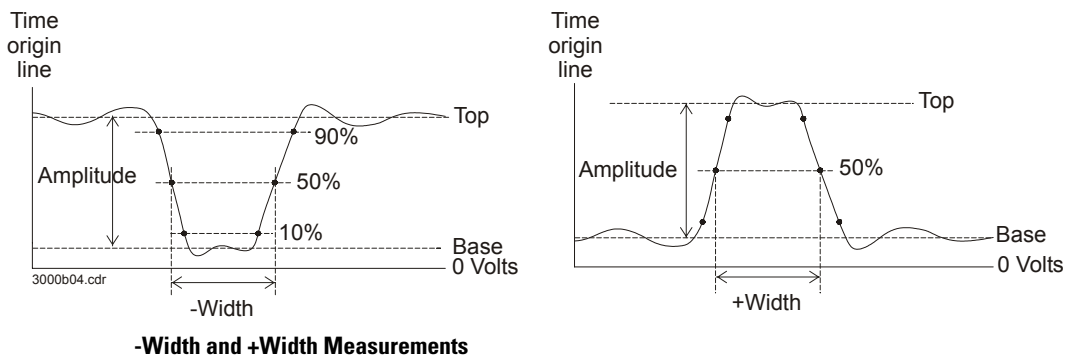
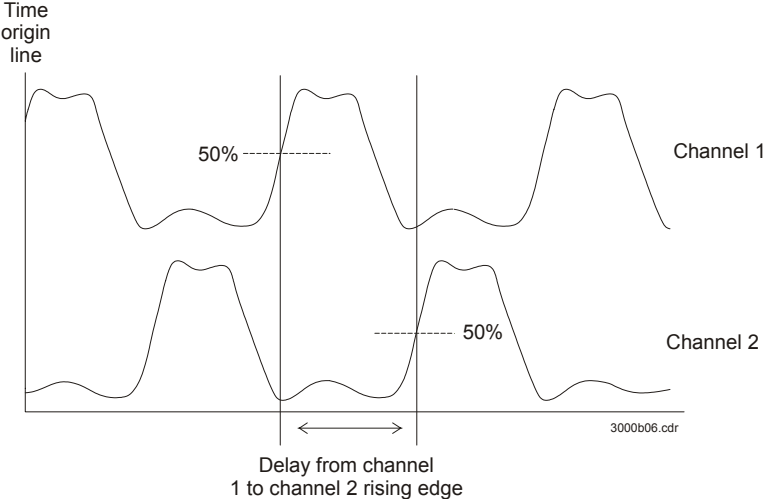
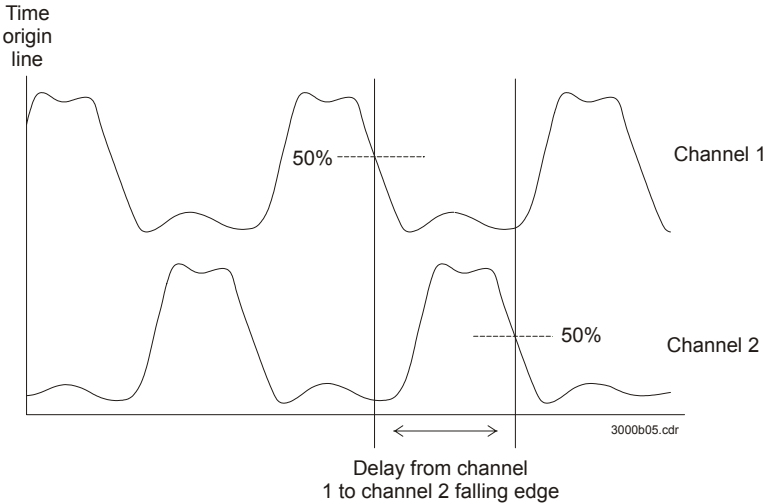


Figure 2-35



**Delay Measurements**

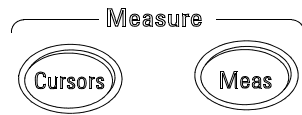


---

# Cursor Measurement Controls

Figure 2-36 shows the location of the **Cursors** button on the front panel.

**Figure 2-36**



## **Cursors Button**

There are three cursor measurement modes.

- Manual
- Track
- Auto Measure

## Manual

In the manual mode, the screen displays two parallel cursors. You can move the cursors to make custom voltage or time measurements on the waveform. The cursor values are displayed in the boxes at the top of the screen. Before using cursors, you should make sure that you have set the waveform source to the channel that is to be measured.

Table 2-31

**Manual Cursors Menu**

Menu	Settings	Comments
Mode	<b>Manual</b>	Set Manual mode for cursor measurement
Type	<b>Voltage</b> <b>Time</b>	Use cursors to measure voltage parameters Use cursors to measure time parameters
Source	<b>CH1</b> <b>CH2</b> <b>Math</b>	Sets the measurement waveform source

To do manual cursor measurements, use the following steps.

- 1 Press the **Mode** menu button until **Manual** appears.
- 2 Press **Type** menu button until the units that you want to measure appears.
- 3 Press the **Source** menu button until the source you want to measure appears.
- 4 Move the cursors to the desired measurement position using the information in Table 2-32.

Cursor movement is only possible while the Cursors menu is being displayed.

Table 2-32

**Manual Cursors Adjustment Controls**

Type	Operation
<b>Voltage</b>	Turn the entry knob to move the selected cursor (A or B) up or down
<b>Time</b>	Turn the entry knob to move the selected cursor (A or B) left or right

Table 2-33

---

<b>Manual Cursors Position Readouts</b>		
Readout	Type	Description
CurA	Voltage	Shows the current voltage value for Cursor A
	Time	Shows the time position for Cursor A
CurB	Voltage	Shows the current voltage value for Cursor A
	Time	Shows the time position for Cursor A
$\Delta Y$	Voltage	Shows the voltage difference between Cursor A and Cursor B
$\Delta X$	Time	Shows the time difference between Cursor A and Cursor B
$1/\Delta X$	Time	Shows the frequency difference between Cursor A and Cursor B

---

---

## Track

In the track mode, the screen displays two cross hair cursors. The cross hair of the cursor is positioned on the waveform automatically. You can adjust the selected cursor's horizontal position on the waveform by turning the entry knob. The oscilloscope displays the values of the coordinates in the boxes at the top of the screen.

**Table 2-34**

---

### Track Cursors Menu

---

<b>Menu</b>	<b>Settings</b>	<b>Comments</b>
Mode	<b>Track</b>	Set Track mode in cursor measurement
Cursor A	<b>CH1</b>	Set Cursor A track the waveform on channel 1
	<b>CH2</b>	Set Cursor A to track the waveform on channel 2
	<b>None</b>	Turn off Cursor A
Cursor B	<b>CH1</b>	Set Cursor B to track the waveform on channel 1
	<b>CH2</b>	Set Cursor B to track the waveform on channel 2
	<b>None</b>	Turn off Cursor B

In cursor track mode, the cursors move with the selected waveform.

---

## Auto Measure

The Auto Measure cursors mode is only available when automatic measurements are on. The oscilloscope displays cursors corresponding to the most recently invoked automatic measurement.

There will be no cursor display if no automatic measurements are selected in the **Measure** menu.

---

## Autoscale and Run/Stop Controls

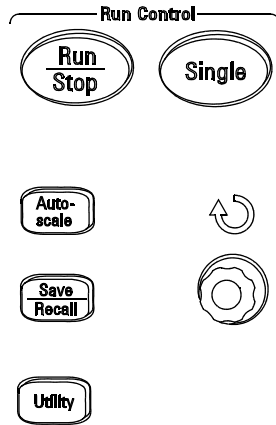
The **Autoscale** button is used to automatically set the oscilloscope controls for the input waveform that is present at the input of the oscilloscope. The **Run/Stop** button is used to manually start or stop the oscilloscope's acquisition system.

---

## Autoscale Button

Figure 2-37 shows the location of the Autoscale button on the front panel.

**Figure 2-37**



### **Autoscale Button**

The **Autoscale** feature automatically adjusts the scope to produce a usable display of the input waveform(s).

Autoscale and Run/Stop Controls  
**Autoscale Button**

After the **Autoscale** button is pressed the oscilloscope is configured to the following default control settings.

**Table 2-35**

<b>Menu</b>	<b>Settings</b>
Display format	Y-T
Sampling mode	Real time
Acquire mode	Normal
Vertical coupling	Adjust to AC or DC according to the waveform
Vertical "V/div"	Adjusted according to the waveform
Vertical Knobs	Coarse mode
Bandwidth limit	OFF
Waveform invert	OFF
Horizontal position	Center
Horizontal "S/div"	Adjusted according to the waveform
Trigger type	Edge
Trigger source	Lowest numbered active channel
Trigger coupling	DC
Trigger voltage	Midpoint (50%) setting
Trigger sweep	Auto



## Run/Stop Button

The **Run/Stop** front panel button starts and stops the oscilloscope's acquisition system. When stopped, the button is red and the vertical and horizontal scales can be adjusted within a fixed range. When the horizontal scale is 50 ms/div or faster, the stopped waveform can be expanded or contracted by 5 horizontal scale steps.





**Specifications**

---

## Specifications

All specifications are warranted. Specifications are valid after a 30-minute warm-up period and  $\pm 5$  °C from last calibration temperature.

Bandwidth (-3dB)	DSO3062A: 60 MHz DSO3102A: 100 MHz DSO3152A: 150 MHz DSO3202A: 200 MHz
DC Vertical Gain Accuracy	2 mV/div to 5 mV/d: $\pm 4.0\%$ full scale 10 mV/div to 5 V/div: $\pm 3.0\%$ full scale

---


## Characteristics

All characteristics are the typical performance values and are not warranted. Characteristics are valid after a 30-minute warm-up period and  $\pm 5$  °C from last calibration temperature.

**Characteristics****Acquisition System**

Max Sample rate	1 GSa/s
Vertical Resolution	8 bits
Peak Detection	5 ns
Averages	selectable from 2, 4, 8, 16, 32, 64, 128, and 256

**Vertical System**

Analog channels	Channels 1 and 2 simultaneous acquisition DSO3062A: 60 MHz DSO3102A: 100 MHz DSO3152A: 150 MHz DSO3202A: 200 MHz
Calculated rise time (= 0.35/bandwidth)	DSO3202A: 1.8 ns DSO3152A: 2.3 ns DSO3102A: 3.5 ns DSO3062A: 5.8 ns
Range <sup>1</sup>	2 mV/div to 5 V/div
Maximum Input	CAT II 1 M $\Omega$ 300 Vrms 
Offset Range	$\pm 2$ V 2 mV/div to 100 mV/div $\pm 40$ V on ranges 102 mV/div to 5 V/div
Input Resistance	1 M $\Omega$ $\pm 1\%$
Input Capacitance	$\sim 13$ pF
Coupling	AC, DC, ground
BW Limit	$\sim 20$ MHz
ESD Tolerance	$\pm 2$ kV
DC Vertical Gain Accuracy	2 mV/div to 5 mV/div: $\pm 4\%$ 10 mV/div to 5 V/div $\pm 3\%$
DC Measurement ( $\geq 16$ waveform averages)	$\pm(3\% \times \text{reading} + 0.1 \text{ div} + 1 \text{ mV})$ when 10 mV/div or greater is selected and vertical position is at zero $\pm(3\% \times (\text{reading} + \text{vertical position}) + 1\% \text{ of vertical position} + 0.2 \text{ div})$ when 10 mV/div or greater is selected and vertical position is not at zero Add 2 mV for settings from 2 mV/div to 200 mV/div Add 50 mV for settings $> 200$ mV/div to 5 V/div

---

**Horizontal**

Range	2 ns/div to 50 s/div
Timebase Accuracy	±100 ppm over any time interval ≥ 1 ms
Modes	Main, Delayed, Roll, XY

---

**Trigger System**

Sources	Channel 1, channel 2, ac line, ext, and ext/5
Sweep	Auto and Normal
Holdoff Time	100 ns to 1.5 s
Selections	
Edge	Trigger on a rising or falling edge of any source
Pulse Width	Trigger when a positive-going or negative-going pulse is less than, greater than, or equal to a specified value on any of the source channels Range: 20 ns to 10 s
Video	Trigger on any analog channel for NTSC, PAL, or SECAM broadcast standards on either positive or negative composite video signals. Modes supported include Even Field, Odd Field, all lines, or any line within a field.

Maximum Input



CAT II 300 Vrms

Trigger Level Range

Internal	±12 divisions from center screen
EXT	± 2.4 V
EXT/5	± 12 V

Sensitivity

DC	CH1, CH2: 1 div (DC to 10 MHz) 1.5 div (10 MHz to full bandwidth) EXT: 100 mV (DC to 10 MHz), 200 mV (10 MHz to full bandwidth) EXT/5: 500 mV (DC to 10 MHz), 1 V (10 MHz to full bandwidth)
AC	Same as DC at 50 Hz and above
LF Reject	Same as DC limits for frequencies above 100 kHz. Waveforms below 8 kHz are attenuated
HF Reject	Same as DC limits for frequencies from DC to 10 kHz. Frequencies above 150 kHz are attenuated

---

**Display System**

Display	5.7-inch (145 mm) diagonal liquid crystal display
Resolution	240 vertical by 320 horizontal pixels
Display Brightness	Adjustable

## Specifications and Characteristics

### Characteristics

---

#### Measurements

##### Automatic Measurements

Voltage	Peak-to-Peak (Vpp), Maximum (Vmax), Minimum (Vmin), Average (Vavg), Amplitude (Vamp), Top (Vtop), Base (Vbase), Overshoot, Preshoot, RMS (Vrms)
Time	Frequency (Freq), Period, Positive Pulse Width (+Width), Negative Pulse Width (-Width), Positive Duty Cycle (+Duty), Minus Duty Cycle (-Duty), Rise Time, Fall Time, Rising Edge Time Delay from Channel 1 to Channel 2 (Delay1→2 $\tau_r$ ), Falling Edge Time Delay from Channel 1 to Channel 2 (Delay1→2 $\tau_f$ ), Hardware Counter

---

#### General Characteristics

##### Physical:

Size	350 mm wide x 288 mm high x 145 mm deep (without handle)
Weight	4.8 kgs

Calibrator Output	Frequency 1 kHz; Amplitude 3 Vpp into 1 M $\Omega$ load
-------------------	---

---

#### Power Requirements

Line Voltage Range	100 to 240 VAC $\pm$ 10%, CAT II, automatic selection
Line Frequency	50 to 440 Hz
Power Usage	50 VA max

---

#### Environmental Characteristics

Ambient Temperature	Operating 0 °C to +55 °C Non-operating -40 °C to +70 °C
Humidity	Operating 95% RH at 40 °C for 24 hr Non-operating 90% RH at 65 °C for 24 hr
Altitude	Operating to 4,570 m (15,00 ft) Non-operating to 15,244 m (50,000 ft)
Vibration	HP/Agilent class B1
Shock	HP/Agilent class B1
Pollution degree2	Normally only dry non-conductive pollution occurs. Occasionally a temporary conductivity caused by condensation must be expected.
Indoor use only	This instrument is rated for indoor use only

#### Installation categories

CAT I: Mains isolated
CAT II: Line voltage in appliance and to wall outlet



---

Service

---

# Returning the oscilloscope to Agilent Technologies for service

Before shipping the oscilloscope to Agilent Technologies, contact your nearest Agilent Technologies oscilloscope Support Center (or Agilent Technologies Service Center if outside the United States) for additional details.

**1 Write the following information on a tag and attach it to the oscilloscope.**

- Name and address of owner
- oscilloscope model numbers
- oscilloscope serial numbers
- Description of the service required or failure indications

**2 Remove all accessories from the oscilloscope.**

Accessories include all cables. Do not include accessories unless they are associated with the failure symptoms.

**3 Protect the oscilloscope by wrapping it in plastic or heavy paper.**

**4 Pack the oscilloscope in foam or other shock absorbing material and place it in a strong shipping container.**

You can use the original shipping materials or order materials from an Agilent Technologies Sales Office. If neither are available, place 8 to 10 cm (3 to 4 inches) of shock-absorbing material around the oscilloscope and place it in a box that does not allow movement during shipping.

**5 Seal the shipping container securely.**

**6 Mark the shipping container as FRAGILE.**

In any correspondence, refer to oscilloscope by model number and full serial number.

---

# Testing Performance

This section documents performance test procedures. Performance verification for the products covered by this manual consists of three main steps:

- Performing the internal product self-tests to ensure that the measurement system is functioning properly
- Calibrating the product
- Testing the product to ensure that it is performing to specification

## **Performance Test Interval**

The procedures in this section may be performed for incoming inspection and should be performed periodically to verify that the oscilloscope is operating within specification. The recommended test interval is once per year or after 2000 hours of operation. Performance should also be tested after repairs or major upgrades.

## **Performance Test Record**

A test record form is provided at the end of this section. This record lists performance tests, test limits and provides space to record test results.

## **Test Order**

The tests in this section may be performed in any order desired. However, it is recommended to conduct the tests in the order presented in this manual as this represents an incremental approach to performance verification. This may be useful if you are attempting to troubleshoot a suspected problem.

## **Test Equipment**

Lists of equipment needed to conduct each test are provided for each test procedure. The procedures are written to minimize the number and types of oscilloscopes and accessories required. The oscilloscopes in these lists are ones that are currently available for sale by Agilent at the time of writing this document. In some cases, the test procedures use features specific to the oscilloscopes in the recommended equipment

list. However, with some modification to the test procedures, oscilloscopes, cables and accessories that satisfy the critical specifications in these lists may be substituted for the recommended models with some modification to the test procedures.

Contact Agilent Technologies for more information about the Agilent products in these lists.

---

## Before Performing Performance Verification Testing

**Let the oscilloscope warm up before testing**

The oscilloscope under test must be warmed up (with the oscilloscope application running) for at least 30 minutes prior to the start of any performance test.

### Equipment Required

Description	Critical Specifications	Recommended Model/ Part Numbers
Digital Multimeter	DC voltage measurement accuracy better than $\pm 0.1\%$ of reading	Agilent 34401A
Cable Assembly	50 $\Omega$ characteristic impedance	Agilent 54855-61620
Cable Assembly	RS-232 (f)(f)	Agilent 34398A
Adapter	BNC Barrel (f)(f)	Agilent 1250-0080
Adapter	BNC shorting cap	Agilent 1250-0929
Adapter	Precision BNC (2)	Agilent 54855-67604
Adapter	BNC (f) to dual banana	Agilent 1251-2277

### Calibration

- 1 Push the **Utility** button on the front panel.
- 2 Select Self-Cal menu item in the Utility menu.
- 3 Follow the on-screen instructions.

---

## Vertical Performance Verification

This section contains the following vertical performance verification:

- DC Gain Accuracy Test
- Analog Bandwidth Test

---

## DC Gain Accuracy Test

### **CAUTION**

Ensure that the input voltage to the oscilloscope never exceeds 300 Vrms.

### **Specifications**

DC Gain Accuracy	±1.5% of full scale at full resolution channel scale
Full scale is defined as 8 vertical divisions. The major scale settings are 2 mV, 5 mV, 10 mV, 20 mV, 50 mV, 100 mV, 200 mV, 500 mV, 1 V, 2 V, and 5 V.	

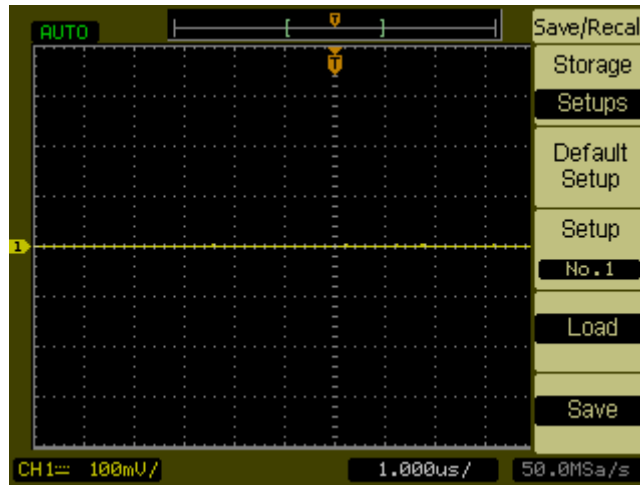
### **Equipment Required**

Description	Critical Specifications	Recommended Model/ Part Numbers
Power Supply	0 V to 35 V dc; 10 mV resolution	Agilent E3633A or E3634A
Digital Multimeter	DC voltage measurement accuracy better than ±0.1% of reading	Agilent 34401A
Cable Assembly (2 required)	50Ω characteristic impedance, BNC (m) connectors	Agilent 8120-1840
Adapter	BNC Tee (m)(f)(f)	Agilent 1250-0781
Adapter (2 required)	BNC (f) to dual banana	Agilent 1251-2277

### **Procedure**

- 1** Disconnect all cables from the oscilloscope channel inputs.
- 2** Press the **Save/Recall** front panel button.
- 3** Select the **Storage** item in the Save/Recall menu until Setups appears.

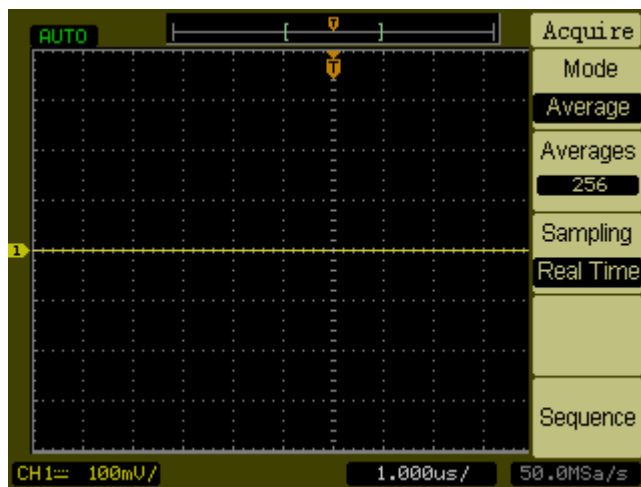
Figure 4-1



- 4 Select the **Default Setup** item in the Save/Recall menu.
- 5 Press the **Acquire** front panel button.
- 6 Select the mode item in the Acquire menu until Average appears.
- 7 Select the **Averages** item in the Acquire menu until 256 appears.

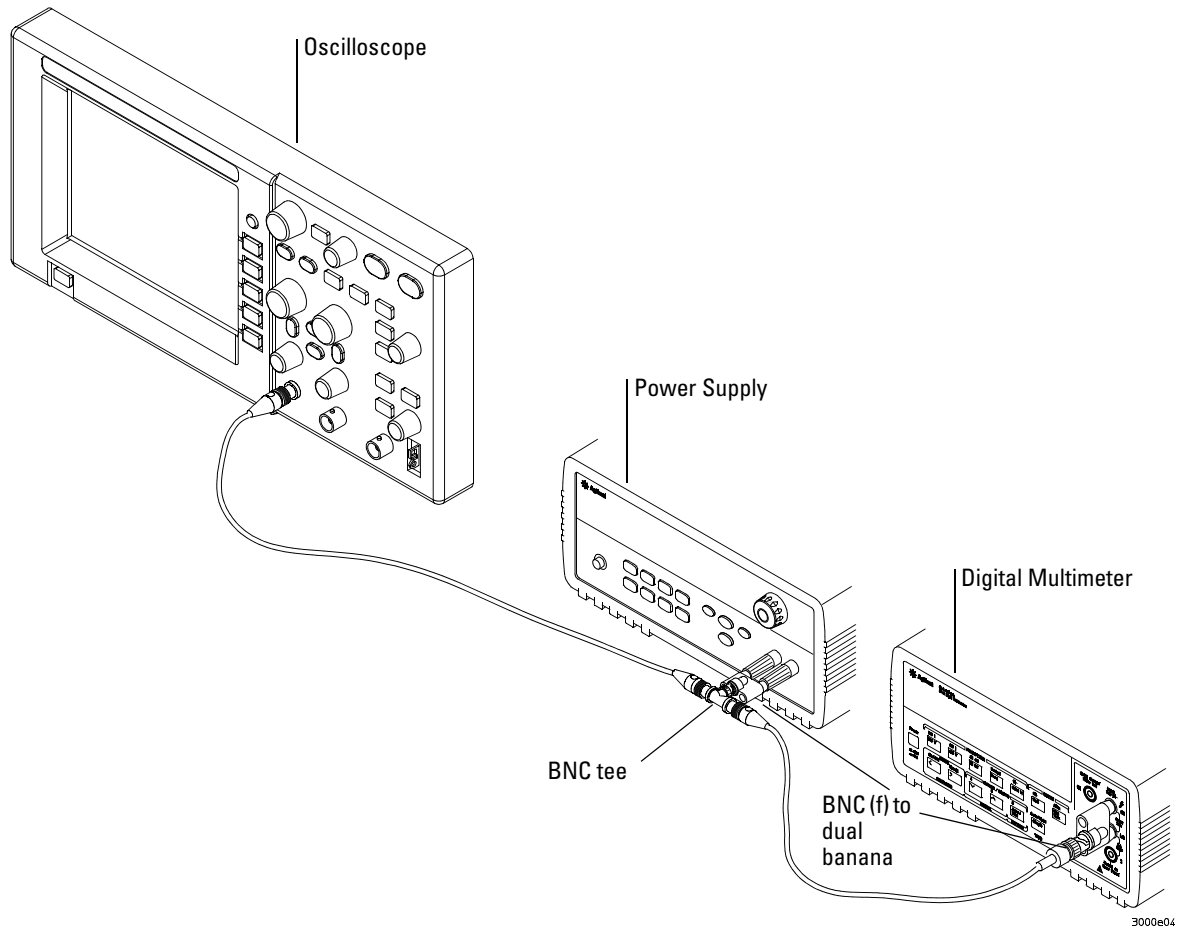


Figure 4-2



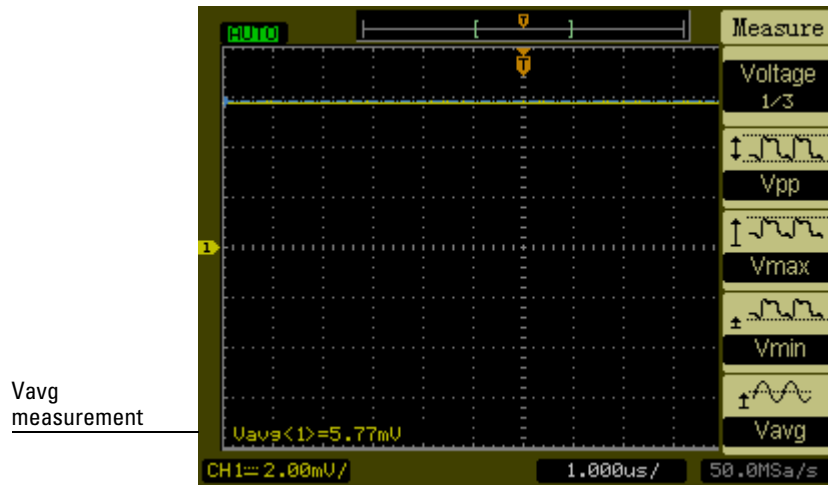
- 8 Set the channel 1 vertical sensitivity value to 2 mV/div.
- 9 Set the power supply to +6 mV.
- 10 Connect the equipment as shown in Figure 4-3.

Figure 4-3



- 11 Press the **Meas** button on the front of the oscilloscope.
- 12 Select the **Voltage** menu item.

- 13 Select the **Vavg** measurement as shown below.



- 14 Record the DMM voltage reading as  $V_{DMM+}$  and the oscilloscope Vavg reading as  $V_{Scope+}$  in the DC Gain Test section of the Performance Test Record.
- 15 Repeat step 14 for the remaining vertical sensitivities for channel 1 in the DC Gain Test section of the Performance Test Record.
- 16 Set the power supply voltage to +6 mV.
- 17 Move the BNC cable on channel 1 to channel 2.
- 18 Press the **Save/Recall** front panel button.
- 19 Select the **Storage** item in the Save/Recall menu until Setups appears.
- 20 Select **Default Setup** in the Save/Recall menu.
- 21 Set the channel 2 vertical sensitivity value to 2 mV/div.
- 22 Press the **Meas** button on the front of the oscilloscope.
- 23 Select the **Voltage** menu item.
- 24 Select the **Vavg** measurement.
- 25 Record the DMM voltage reading as  $V_{DMM-}$  and the oscilloscope Vavg reading as  $V_{Scope-}$  in the DC Gain Test section of the Performance Test Record.
- 26 Repeat step 25 for the remaining vertical sensitivities for channel 2 in the DC Gain section of the Performance Test Record.

- 27** Calculate the DC Gain using the following expression and record this value in the DC Gain Test section of the Performance Test Record:

$$DCGain = \frac{\Delta V_{out}}{\Delta V_{in}} = \frac{V_{scope+} - V_{scope-}}{V_{DMM+} - V_{DMM-}}$$

## Analog Bandwidth - Maximum Frequency Check

**CAUTION**

Ensure that the input voltage to the oscilloscope never exceeds 300 Vrms.

**Specification**

Analog Bandwidth (-3 dB)	
DSO3062A	60 MHz
DSO3102A	100 MHz
DSO3152A	150 MHz
DSO3202A	200 MHz

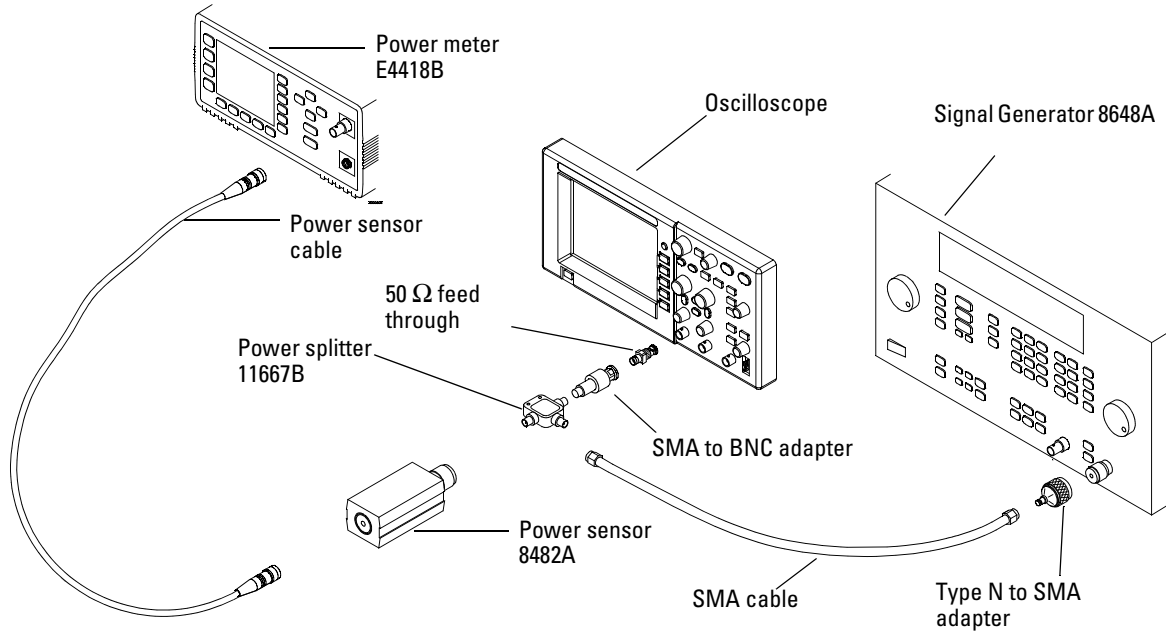
**Equipment Required**

Description	Critical Specifications	Recommended Model/ Part Numbers
Signal Generator	100 kHz to 1 GHz at 200 mVrms	Agilent 8648A
Power Splitter	outputs differ by < 0.15 dB	Agilent 11667B
Power Meter	Agilent E-series with power sensor compatibility	Agilent E4418B
Power Sensor	100 kHz to 1 GHz $\pm$ 3% accuracy	Agilent 8482A
SMA Cable	SMA (m) to SMA (m) 24 inch	
Adapter	50 $\Omega$ BNC feed through terminator	
Adapter	Type N (m) to SMA (f)	Agilent 1250-1250
Adapter	Type SMA (m) to BNC (m)	Agilent 1250-0831

### Connections

Connect the equipment as shown in Figure 4-4.

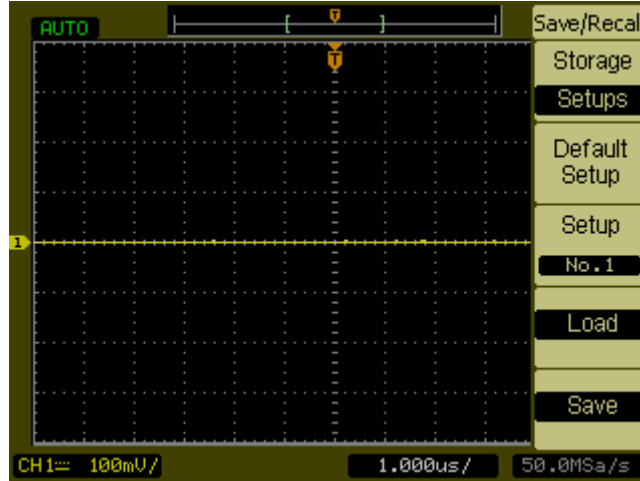
Figure 4-4



### Procedure

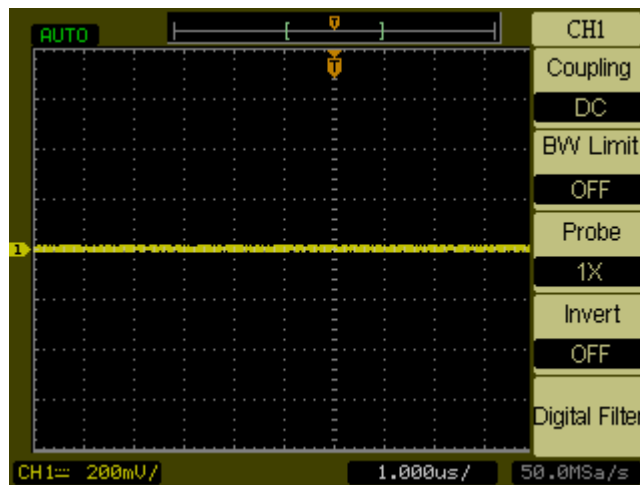
- 1 Preset and calibrate the power meter according to the instructions found in the power meter manual.
- 2 Set up the Power Meter to display measurements in units of Watts.
- 3 On the oscilloscope, press the **Save/Recall** front panel button.
- 4 Select the **Storage** item in the **Save/Recall** menu until **Setups** appears.

Figure 4-5



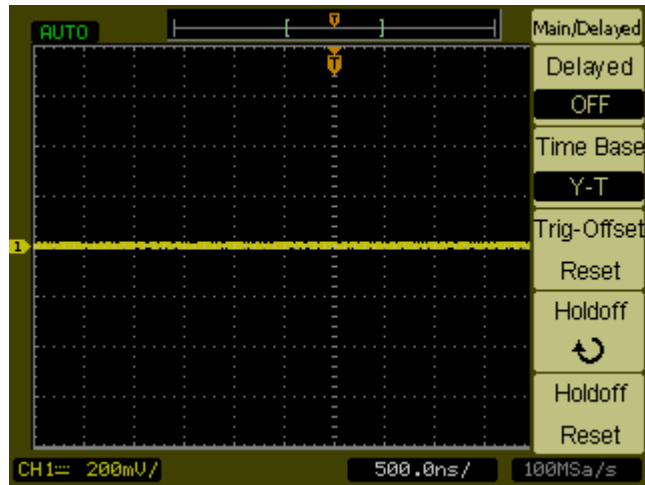
- 5 Select the **Default Setup** item in the Save/Recall menu.
- 6 Press the **Autoscale** front panel button.
- 7 Set the channel 1 vertical scale to 200 mV/div.

Figure 4-6



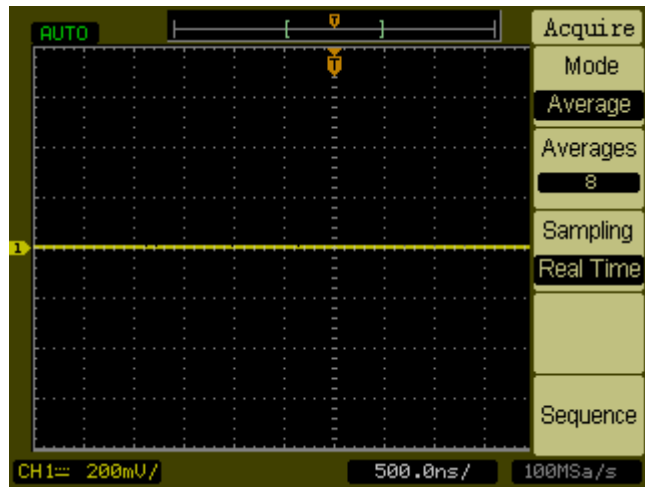
- 8 Set the horizontal scale to 500 ns/div.

Figure 4-7



- 9 Press the **Acquire** front panel button.
- 10 Select the **Mode** menu item until Average appears.
- 11 Select the **Average** menu item until 8 appears.

Figure 4-8

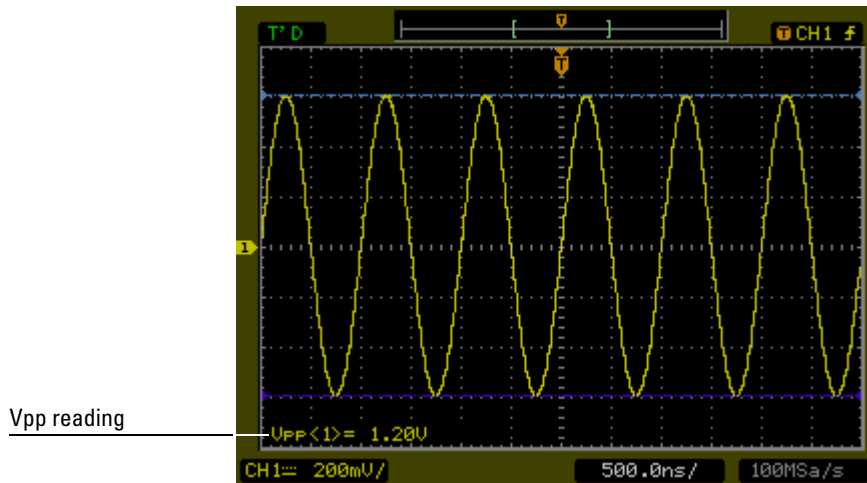


- 12 Press the **Meas** front panel button.
- 13 Select the **Voltage** menu item.



- 14 Select the **Voltage** menu item until **2/3** appears.
- 15 Select the **Vpp** menu item.
- 16 Set the signal generator to a 1 MHz sine wave with a peak-to-peak amplitude of about 6 divisions as it appears on the oscilloscope screen.

Figure 4-9



- 17 Using the Vpp reading, calculate the Vrms value using the following expression and record it in the Performance Test Record (page 4-22):

$$V_{out_{1MHz}} = \frac{V_{PP_{1MHz}}}{2\sqrt{2}}$$

**Example**

For  $V_{pp} = 1.20 \text{ V}$

$$V_{out_{1MHz}} = \frac{1.20}{2\sqrt{2}} = \frac{1.20}{2.828} = 424 \text{ mV}$$

- 18** Using the power meter reading, convert this measurement to Volts RMS using the expression and record it in the Performance Test Record (page 4-22):

$$V_{in_{1MHz}} = \sqrt{P_{meas} \times 50\Omega}$$

---

**Example**

For  $P_{meas} = 3.65 \text{ mW}$ .

$$V_{in_{1MHz}} = \sqrt{3.65 \text{ mW} \times 50\Omega} = 427 \text{ mV}$$


---

- 19** Calculate the reference gain as follows:

$$Gain_{1MHz} = \frac{V_{out_{1MHz}}}{V_{in_{1MHz}}}$$

Record this value in the Calculated Gain @ 1 MHz column of the Performance Test Record (page 4-22).

- 20** Change the signal generator frequency to the value for the model being tested as shown in the table below.

Setting	Model			
	DS03062A	DS03102A	DS03152A	DS03202A
Frequency	60 MHz	100 MHz	150 MHz	200 MHz
Time Base	10 ns/div	5 ns/div	5 ns/div	2 ns/div

- 21** Change the oscilloscope time base to the value for the model being tests as shown in the table above.
- 22** Using the  $V_{pp}$  reading, calculate the  $V_{rms}$  value using the following expression and record it in the Performance Test Record (page 4-22):

$$V_{out_{max}} = \frac{V_{PP_{max}}}{2\sqrt{2}}$$

---

**Example** For  $V_{pp} = 1.24 \text{ V}$

$$V_{out_{max}} = \frac{1.05}{2\sqrt{2}} = \frac{1.05}{2.828} = 371 \text{ mV}$$


---

- 23** Using the power meter reading, convert this measurement to Volts RMS using the expression and record it in the Performance Test Record (page 4-22):

$$V_{in_{max}} = \sqrt{P_{meas} \times 50\Omega}$$

---

**Example** For  $P_{meas} = 3.65 \text{ mW}$ .

$$V_{in_{max}} = \sqrt{3.65 \text{ mW} \times 50\Omega} = 427 \text{ mV}$$


---

- 24** Calculate the gain at the maximum frequency using the expression and record it in the Performance Test Record (page 4-22):

$$Gain_{max} = 20 \log_{10} \left[ \frac{(V_{out_{max}})/(V_{in_{max}})}{Gain_{1MHz}} \right]$$

---

**Example** For example, if  $(V_{out} @ \text{Max Frequency}) = 371 \text{ mV}$ ,  $(V_{in} @ \text{Max Frequency}) = 427 \text{ mV}$  and  $\text{Gain} @ 1 \text{ MHz} = 0.993$ , then:

$$Gain_{Max \text{ Freq}} = 20 \log_{10} \left[ \frac{371 \text{ mV}/427 \text{ mV}}{0.993} \right] = -1.16 \text{ dB}$$


---

Record this value in the Calculated Gain @Max Freq column in the Analog Bandwidth - Maximum Frequency Check section of the Performance Test Record. To pass this test, this value must be greater than -3.0 dB.

Service  
**Analog Bandwidth - Maximum Frequency Check**

- 25** Move the power splitter from channel 1 to channel 2 and repeat steps 3 through 24 using channel 2 as the source.

## Performance Test Record

### DC Gain Test

Vertical Sensitivity	Power Supply Setting	V <sub>DMM+</sub>	V <sub>DMM-</sub>	V <sub>Scope+</sub>	V <sub>Scope-</sub>	Calculated DC Gain	Offset Gain Test Limits
<b>Channel 1</b>							
2 mV/div	±6 mV						+0.96 to +1.04
5 mV/div	±15 mV						+0.96 to +1.04
10 mV/div	±30 mV						+0.97 to +1.03
20 mV/div	±60 mV						+0.97 to +1.03
50 mV/div	±150 mV						+0.97 to +1.03
100 mV/div	±300 mV						+0.97 to +1.03
200 mV/div	±600 mV						+0.97 to +1.03
500 mV/div	±1.5 V						+0.97 to +1.03
1 V/div	±2.4 V						+0.97 to +1.03
2 V/div	±6.0 V						+0.97 to +1.03
5 V/div	±15.0 V						+0.97 to +1.03
<b>Channel 2</b>							
2 mV/div	±6 mV						+0.96 to +1.04
5 mV/div	±15 mV						+0.96 to +1.04
10 mV/div	±30 mV						+0.97 to +1.03
20 mV/div	±60 mV						+0.97 to +1.03
50 mV/div	±150 mV						+0.97 to +1.03
100 mV/div	±300 mV						+0.97 to +1.03
200 mV/div	±600 mV						+0.97 to +1.03
500 mV/div	±1.5 V						+0.97 to +1.03
1 V/div	±2.4 V						+0.97 to +1.03
2 V/div	±6.0 V						+0.97 to +1.03
5 V/div	±15.0 V						+0.97 to +1.03

**Analog Bandwidth - Maximum Frequency Check**

Max frequency: DS03062A = 60 MHz, DS03102A = 100 MHz, DS03152A = 150 MHz, DS031202A = 200 MHz

	<b>Vin @ 1 MHz</b>	<b>Vout @ 1 MHz</b>	<b>Calculated Gain @ 1 MHz (Test Limit = greater than -3 dB)</b>	<b>Vin @ Max Freq</b>	<b>Vout @ Max Freq</b>	<b>Calculated Gain @ Max Freq (Test Limit = greater than -3 dB)</b>
<b>Channel 1</b>						
<b>Channel 2</b>						

---

# Index

---

## A

- accessories
  - supplied 1-2
- Acquire
  - Average 2-38
  - Equivalent time sampling 2-38
  - Peak detect 2-40
- Auto measurement cursors 2-67
- Automatic measurements 2-55
- Auto-scale 1-12
- Auto-Scale button 2-69
- Average acquisition 2-38

## B

- Bandwidth limit control 2-9

## C

- cables
  - power 1-4
- Calibration
  - Oscilloscope 2-53
- cautions
  - cleaning 1-13
- Channel
  - Digital filter control 2-14
  - Invert control 2-12
  - Probe attenuation control 2-11
- Channel Controls
  - Coupling 2-6
- Channels
  - Bandwidth limit control 2-9
- checking the oscilloscope 1-2
- Cleaning oscilloscope 1-13
- cleaning the instrument 1-1
- cleaning the oscilloscope 1-13
- Compensating probes 1-7
- contents
  - of oscilloscope package 1-2
- Controls
  - Vertical 2-3
- Coupling control 2-6
- Cursor measurements 2-63
  - Manual 2-64
  - Track mode 2-66
- Cursors
  - Auto measure 2-67

## D

- Digital filter controls 2-14
- Display
  - Controls 2-43

## E

- Edge trigger 2-33
- Equivalent time sampling 2-38

## F

- Functional check 1-5

## G

- GPIB control 2-51

## H

- Horizontal
  - Controls 2-22
  - Main/Delayed control 2-25

## I

- I/O settings 2-51
- inspecting the oscilloscope 1-2
- Invert control 2-12

## M

- Manual cursor measurements 2-64
- manuals 1-2
- Math functions 2-15
- Measurement
  - Concepts 2-59
- Measurements
  - Automatic 2-55
  - Cursor 2-63
  - Time 2-57

## O

- options
  - power cable 1-4
- Oscilloscope
  - Cleaning 1-13
- oscilloscope
  - cleaning 1-13
  - inspecting 1-2

## P

- package contents 1-2
- packing for return 4-2
- Peak detect 2-40
- performance characteristics 3-1
- plugs
  - power 1-4
- power cables 1-4
- Probe Attenuation control 2-11
- Probes
  - Compensating 1-7

## R

- Recalling
  - Factory setup 2-45
  - Setups 2-45
  - Waveforms 2-45
- Ref control 2-19
- returning the instrument to Agilent 4-2
- Roll mode 2-29
- RS-232 control 2-51
- Run button 2-71

## S

- Saving
  - Setups 2-45
  - Waveforms 2-45
- Self-Calibration control 2-53
- Self-Test 2-54
- Sequence capability control 2-41
- standard accessories 1-2
- Stop button 2-71
- Stop control 2-38

## T

- Testing oscilloscope 1-5
- Time measurements 2-57
- Timebase
  - Main/Delayed 2-25
- Track cursors 2-66
- Trigger
  - Controls 2-30
  - Edge 2-33
  - Modes 2-33
  - Video 2-34
- Trigger holdoff control 2-28

## U

### Utility

- Controls 2-47
- GPIB control 2-51
- I/O settings 2-51
- RS-232 control 2-51
- Self-Calibration control 2-53
- Self-Test 2-54
- Sequence Capability control 2-41

## V

### Vertical

- Bandwidth limit control 2-9
  - Controls 2-3
  - Coupling control 2-6
  - Digital filter control 2-14
  - Invert control 2-12
  - Math functions control 2-15
  - Probe attenuation control 2-11
  - Ref control 2-19
- Video trigger 2-34

## W

### Waveform

- Controls 2-37
- Roll mode 2-29



# Safety Notices

This apparatus has been designed and tested in accordance with IEC Publication 1010, Safety Requirements for Measuring Apparatus, and has been supplied in a safe condition. This is a Safety Class I instrument (provided with terminal for protective earthing). Before applying power, verify that the correct safety precautions are taken (see the following warnings). In addition, note the external markings on the instrument that are described under "Safety Symbols."

## Warnings

- Before turning on the instrument, you must connect the protective earth terminal of the instrument to the protective conductor of the (mains) power cord. The mains plug shall only be inserted in a socket outlet provided with a protective earth contact. You must not negate the protective action by using an extension cord (power cable) without a protective conductor (grounding). Grounding one conductor of a two-conductor outlet is not sufficient protection.
- Only fuses with the required rated current, voltage, and specified type (normal blow, time delay, etc.) should be used. Do not use repaired fuses or short-circuited fuseholders. To do so could cause a shock or fire hazard.
- If you energize this instrument by an auto transformer (for voltage reduction or mains isolation), the common terminal must be connected to the earth terminal of the power source.

- Whenever it is likely that the ground protection is impaired, you must make the instrument inoperative and secure it against any unintended operation.

- Service instructions are for trained service personnel. To avoid dangerous electric shock, do not perform any service unless qualified to do so. Do not attempt internal service or adjustment unless another person, capable of rendering first aid and resuscitation, is present.

- Do not install substitute parts or perform any unauthorized modification to the instrument.

- Capacitors inside the instrument may retain a charge even if the instrument is disconnected from its source of supply.

- Do not operate the instrument in the presence of flammable gasses or fumes. Operation of any electrical instrument in such an environment constitutes a definite safety hazard.

- Do not use the instrument in a manner not specified by the manufacturer.

## To clean the instrument

If the instrument requires cleaning: (1) Remove power from the instrument. (2) Clean the external surfaces of the instrument with a soft cloth dampened with a mixture of mild detergent and water. (3) Make sure that the instrument is completely dry before reconnecting it to a power source.

## Safety Symbols



Instruction manual symbol: the product is marked with this symbol when it is necessary for you to refer to the instruction manual in order to protect against damage to the product.



Hazardous voltage symbol.



Earth terminal symbol: Used to indicate a circuit common connected to grounded chassis.

# Notices

© Agilent Technologies, Inc.  
2005

No part of this manual may be reproduced in any form or by any means (including electronic storage and retrieval or translation into a foreign language) without prior agreement and written consent from Agilent Technologies, Inc. as governed by United States and international copyright laws.

**Manual Part Number**  
D3000-97000, March 2005

**Print History**  
D3000-97000, March 2005

## Restricted Rights Legend

If software is for use in the performance of a U.S. Government prime contract or subcontract, Software is delivered and licensed as "Commercial computer software" as defined in DFAR 252.227-7014 (June 1995), or as a "commercial item" as defined in FAR 2.101(a) or as "Restricted computer software" as defined in FAR 52.227-19 (June 1987) or any equivalent agency regulation or contract clause. Use, duplication or disclosure of Software is subject to Agilent Technologies' standard commercial license terms, and non-DOD Departments and Agencies of the U.S. Government will receive no greater than Restricted Rights as defined in FAR 52.227-19(c)(1-2) (June 1987). U.S. Government users will receive no greater than Limited Rights as defined in FAR 52.227-14 (June 1987) or DFAR 252.227-7015 (b)(2) (November 1995), as applicable in any technical data.

## Document Warranty

The material contained in this document is provided "as is," and is subject to being changed, without notice, in future editions. Further, to the maximum extent permitted by applicable law, Agilent disclaims all warranties, either express or implied, with regard to this manual and any information contained herein, including but not limited to the implied warranties of merchantability and fitness for a particular purpose. Agilent shall not be liable for errors or for incidental or consequential damages in connection with the furnishing, use, or performance of this document or of any information contained herein. Should Agilent and the user have a separate written agreement with warranty terms covering the material in this document that conflict with these terms, the warranty terms in the separate agreement shall control.

## Technology Licenses

The hardware and/or software described in this document are furnished under a license and may be used or copied only in accordance with the terms of such license.

## WARNING

A WARNING notice denotes a hazard. It calls attention to an operating procedure, practice, or the like that, if not correctly performed or adhered to, could result in personal injury or death. Do not proceed beyond a WARNING notice until the indicated conditions are fully understood and met.

## CAUTION

A CAUTION notice denotes a hazard. It calls attention to an operating procedure, practice, or the like that, if not correctly performed or adhered to, could result in damage to the product or loss of important data. Do not proceed beyond a CAUTION notice until the indicated conditions are fully understood and met.

## Trademark Acknowledgements